

## Industrial Automation Headquarters

**Delta Electronics, Inc.**  
 Taoyuan Technology Center  
 No.18, Xinglong Rd., Taoyuan City,  
 Taoyuan County 33068, Taiwan  
 TEL: 886-3-362-6301 / FAX: 886-3-371-6301

## Asia

**Delta Electronics (Jiangsu) Ltd.**  
 Wujiang Plant 3  
 1688 Jiangxing East Road,  
 Wujiang Economic Development Zone  
 Wujiang City, Jiang Su Province, P.R.C. 215200  
 TEL: 86-512-6340-3008 / FAX: 86-769-6340-7290

**Delta Greentech (China) Co., Ltd.**  
 238 Min-Xia Road, Pudong District,  
 ShangHai, P.R.C. 201209  
 TEL: 86-21-58635678 / FAX: 86-21-58630003

**Delta Electronics (Japan), Inc.**  
 Tokyo Office  
 2-1-14 Minato-ku Shibadaimon,  
 Tokyo 105-0012, Japan  
 TEL: 81-3-5733-1111 / FAX: 81-3-5733-1211

**Delta Electronics (Korea), Inc.**  
 1511, Byucksan Digital Valley 6-cha, Gasan-dong,  
 Geumcheon-gu, Seoul, Korea, 153-704  
 TEL: 82-2-515-5303 / FAX: 82-2-515-5302

**Delta Electronics Int'l (S) Pte Ltd.**  
 4 Kaki Bukit Ave 1, #05-05, Singapore 417939  
 TEL: 65-6747-5155 / FAX: 65-6744-9228

**Delta Electronics (India) Pvt. Ltd.**  
 Plot No 43 Sector 35, HSIIIDC  
 Gurgaon, PIN 122001, Haryana, India  
 TEL : 91-124-4874900 / FAX : 91-124-4874945

## Americas

**Delta Products Corporation (USA)**  
 Raleigh Office  
 P.O. Box 12173, 5101 Davis Drive,  
 Research Triangle Park, NC 27709, U.S.A.  
 TEL: 1-919-767-3800 / FAX: 1-919-767-8080

**Delta Greentech (Brasil) S.A.**  
 Sao Paulo Office  
 Rua Itapeva, 26 - 3° andar Edificio Itapeva One-Bela Vista  
 01332-000-São Paulo-SP-Brazil  
 TEL: 55 11 3568-3855 / FAX: 55 11 3568-3865

## Europe

**Deltronics (The Netherlands) B.V.**  
 Eindhoven Office  
 De Witbogt 20, 5652 AG Eindhoven, The Netherlands  
 TEL: 31-40-2592850 / FAX: 31-40-2592851

DVP-0051720-01

\*We reserve the right to change the information in this manual without prior notice.



# DVP201/202/211LC-SL Load Cell Module Operation Manual

# DVP201/202/211LC-SL Load Cell Module

## Operation Manual

### Table of Contents

#### Chapter 1 Introduction

1.1	Principle of a Load Cell.....	1-2
1.2	Introduction of a Load Cell .....	1-2
1.3	Functional Specifications .....	1-2

#### Chapter 2 Dimensions and Profile

2.1	Dimensions .....	2-2
2.2	Profile .....	2-2
2.3	Arrangement of the Terminals .....	2-3
2.4	Description of the Indicators.....	2-3

#### Chapter 3 Installation and Wiring

3.1	Installation .....	3-2
3.1.1	Connecting a Load Cell Module to a DVP-SV series PLC.....	3-2
3.1.2	Installing a DVP-SV series PLC and a Load Cell Module on a DIN rail.....	3-2
3.2	Communication .....	3-3
3.3	External Wiring.....	3-4
3.4	Selecting a Load Cell Sensor.....	3-6

#### Chapter 4 Control Registers

4.1	Table of Control Registers .....	4-2
4.2	Descriptions of the Control Registers .....	4-5
4.3	Descriptions of Functions .....	4-9
4.3.1	Measuring a Net Weight .....	4-9
4.3.2	Stability Check .....	4-10
4.3.3	Determining Zero.....	4-11
4.3.4	Filtering out Weights .....	4-11
4.3.5	Correspondence between Current Outputs and Weights.....	4-12

#### Chapter 5 Making Adjustment

5.1	Steps in Adjusting Points.....	5-3
-----	--------------------------------	-----

5.2 Example 1 ..... 5-4  
5.3 Example 2 ..... 5-5

# 1

## Chapter 1 Introduction

### Table of Contents

1.1	Principle of a Load Cell.....	1-2
1.2	Introduction of a Load Cell .....	1-2
1.3	Functional Specifications .....	1-2



Thanks for using the load cell module DVP201/202/211LC-SL. To ensure that the product is correctly installed and operated, users need to read the operation manual carefully before they use DVP201/202/211LC-SL.

- ✓ The operation manual provides functional specifications, and introduces installation, basic operation and setting, and the usage of DVP201/202/211LC-SL.
- ✓ DVP201/202/211LC-SL is an OPEN-TYPE device. It should be installed in a control cabinet free of airborne dust, humidity, electric shock and vibration. To prevent non-maintenance staff from operating DVP201/202/211LC-SL, or to prevent an accident from damaging DVP201/202/211LC-SL, the control cabinet in which DVP201/202/211LC-SL is installed should be equipped with a safeguard. For example, the control cabinet in which DVP201/202/211LC-SL is installed can be unlocked with a special tool or key. DO NOT touch any terminal when DVP201/202/211LC-SL is powered up.
- ✓ In order to prevent the product from being damaged, or prevent staff from being hurt, users need to read the operation manual carefully, and follow the instructions in the manual.

## 1.1 Principle of a Load Cell

If a metallic material undergoes tension or strain, it will become thin, and its electrical impedance will increase. If a metallic material is compressed, its electrical impedance will become small. A strain gauge adopting this principle is called a load cell. Such sensing device is able to convert physical pressure into electrical signals, and therefore it is widely used on occasions on which loads, tension and pressure need to be converted into electrical signals.

## 1.2 Introduction of a Load Cell

A load cell module provides 24-bit resolution applicable to 4-wire or 6-wire load cells with various eigenvalues. Therefore, its response time can be adjusted according to users' requirements. On this basis, the requirements of load application markets can be easily met. Besides, a DVP series PLC\* can read data in a load cell module or write data to a load cell module by means of the instruction FROM/TO.

\*: DVP-SV series PLCs, DVP-EH2-L series PLCs, DVP-SA2 series PLCs, and DVP-SX2 series PLCs support left-side extension modules.

## 1.3 Functional Specifications

DVP201/202/211LC-SL	
Load cell module	Voltage output
Rated supply voltage/Power consumption	24 V DC (-15 to +20%)/5 W
Static minimum/maximum voltage	20.4 V/28.8 V DC
Dynamic minimum/maximum voltage	18.5 V/30.2 V DC
Maximum current consumption	150 mA
Input signal range	±200 mV DC
Sensibility	+5 V DC +/-5%
ADC resolution	24 bits
Highest precision	0.04%
Communication interface	RS-232, RS-485
Applicable sensor type	4-wire or 6-wire load cell
Expanding a temperature coefficient	≤ ± 20 ppm/K v. E
Reducing a temperature coefficient to zero	≤ ± 0.1 μV/K
Linearity error	≤ 0.015%
Response time	2.5, 10, 16, 20, 50, 60, 100, 200, and 400ms
Eigenvalue applicable to a load cell	0~1, 0~2, 0~4, 0~6, 0~20, 0~40 and 0~80 mV/V

DVP201/202/211LC-SL	
Load cell module	Voltage output
Maximum distance for connecting a load cell	100 meters
Maximum output current	5 V DC * 300 mA
Allowable load	40~4,010 Ω
Averaging weights	100
Common-mode rejection ratio (CMRR @50/60 Hz)	≥100 dB
Isolation	Between a digital circuit and the ground: 500 V AC Between an analog circuit and the ground: 500 V AC Between an analog circuit and a digital circuit: 500 V AC
Connecting to a DVP series PLC	Load cell modules can be connected to the left side of a PLC. The modules connected to a PLC are numbered from 100 to 107 according to the closeness to the PLC.
Operation/Storage	Operation: 0~55°C (temperature), 5~95% (humidity), pollution degree 2 Storage: -25~70°C (temperature), 5~95% (humidity)
Vibration/Shock resistance	International standards: IEC 61131-2, IEC 68-2-6 (TEST Fc)/IEC 61131-2 & IEC 68-2-27 (TEST Ea)

	DVP211LC-SL	
	Electrical specifications for input terminals	Electrical specifications for output terminals
Input/Output terminal	X0, X1	Y0, Y1, Y2, Y3
Type	Digital input	Transistor
Form	DC (sinking or sourcing)	--
Specifications	Input current: 24 V DC, 5 mA	Voltage specifications: 5~30 V DC #1
Input impedance	4.7 KΩ	--
Maximum switch frequency	10 kHz	1 kHz
Action level	Off → On	> 15 V DC
	On → Off	< 5 V DC
Response time	Off → On	< 20 μs
	On → Off	< 50 μs
Maximum load	Resistive load	0.5 A/output (4 A/COM)#2
	Inductive load	15 W (30 V DC)
	Bulb	2.5 W (30 V DC)

Note: In order to meet DIN 1319-1, an error needs to be less than or equal to 0.05% at 20 °C + 10 K.

#1: UP and ZP should be connected to a 24 V DC power supply. The current that an output terminal consumes is approximately 1 mA.

#2: In an NPN mode, ZP is used. In a PNP mode, UP is used.

**MEMO**



# 2

## Chapter 2 Dimensions and Profile

### Table of Contents

2.1	Dimensions .....	2-2
2.2	Profile .....	2-2
2.3	Arrangement of the Terminals .....	2-3
2.4	Description of the Indicators.....	2-3



## 2.1 Dimensions

2

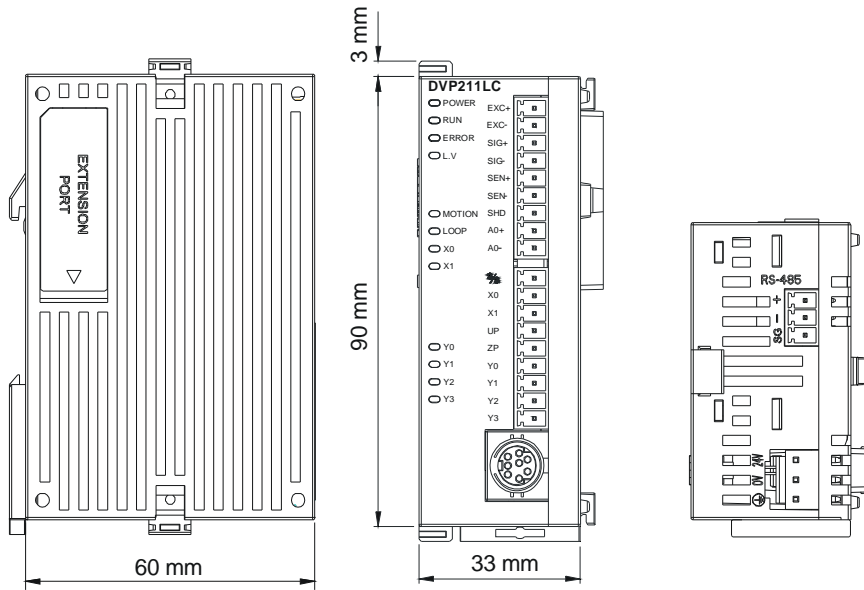

Unit: mm

## 2.2 Profile

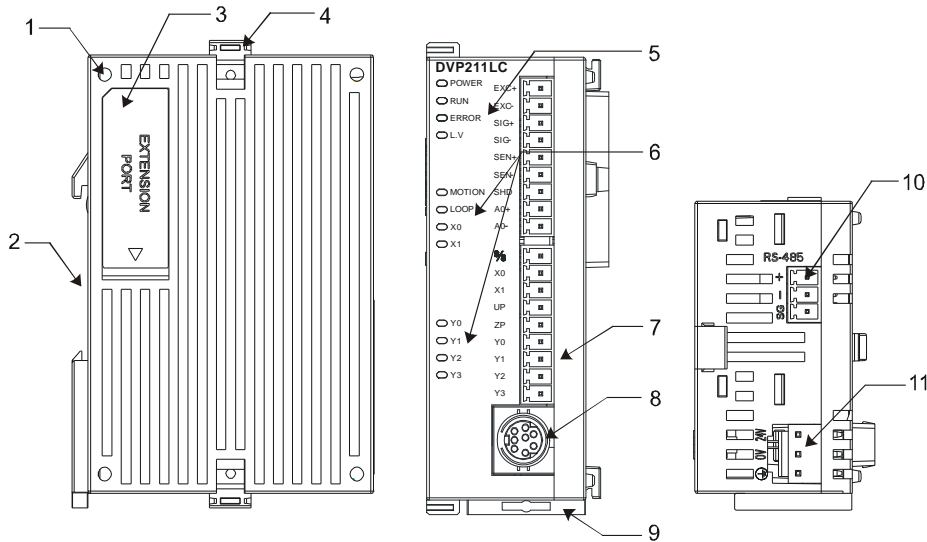

1. Mounting hole	2. Mounting groove (35mm)
3. Extension port	4. I/O module clip
5. POWER indicator, RUN indicator, ERROR indicator and L.V indicator	6. MOTION indicator, LOOP indicator, DI (X0, X1)/DO (Y0-Y3) indicators
7. I/O terminals	8. RS-232 port
9. DIN rail clip	10. RS-485 port
11. Power input	

## 2.3 Arrangement of the Terminals

EXC+	EXC-	SIG+	SIG-	SEN+	SEN-	SHD	•	•
<b>DVP201LC-SL</b>								

EXC+	EXC-	SIG+	SIG-	SEN+	SEN-	SHD	•	•	EXC+	EXC-	SIG+	SIG-	SEN+	SEN-	SHD	•	•
<b>DVP202LC-SL</b>																	

EXC+	EXC-	SIG+	SIG-	SEN+	SEN-	SHD	AO+	AO-	S/S	X0	X1	UP	ZP	Y0	Y1	Y2	Y3
<b>DVP211LC-SL</b>																	

## 2.4 Description of the Indicators

Name	Color	Function
POWER indicator	Green	Displaying power
RUN indicator	Green	Displaying the status of the module
ERROR indicator	Red	Displaying an error
L.V indicator	Red	Showing that the voltage of the an external power is low
LOOP indicator	Green	Loop control
Motion indicator	Orange	Showing that measurement is stable
X0 indicator/X1 indicator	Red	Showing that X0/X1 is On/Off
Y0 indicator/Y1 indicator/ Y2 indicator/Y3 indicator	Red	Showing that Y0/Y1/Y2/Y3 is On/Off

2

**MEMO**

2

# 3

## Chapter 3 Installation and Wiring

### Table of Contents

3.1	Installation .....	3-2
3.1.1	Connecting a Load Cell Module to a DVP-SV series PLC.....	3-2
3.1.2	Installing a DVP-SV series PLC and a Load Cell Module on a DIN rail.....	3-2
3.2	Communication .....	3-3
3.3	External Wiring.....	3-4
3.4	Selecting a Load Cell Sensor.....	3-6

### 3.1 Installation

#### 3.1.1 Connecting a Load Cell Module to a DVP-SV series PLC

- Pull the I/O module clips on a DVP-SV series PLC. Insert the points in the corner of a load cell module into the four holes in the DVP-SV series PLC. Please see step ① in the figure below.
- Press the I/O module clips on the DVP-SV series PLC, and make sure that the load cell module is tightly connected to the DVP-SV series PLC. Please see step ② in the figure below.

3

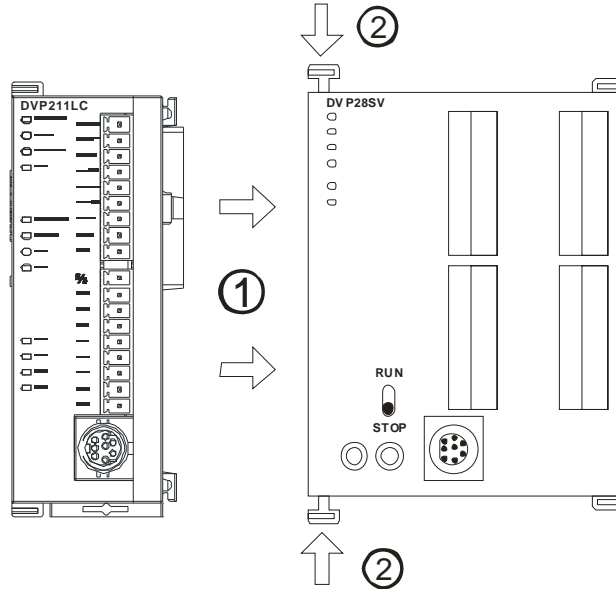

#### 3.1.2 Installing a DVP-SV series PLC and a Load Cell Module on a DIN rail

- Please use a 35 mm DIN rail.
- Pull the DIN rail clips on a DVP-SV series PLC and a load cell module. Install the DVP-SV series PLC and the load cell module on the DIN rail.
- Press the DIN rail clips on the DVP-SV series PLC. Please see the figure below.

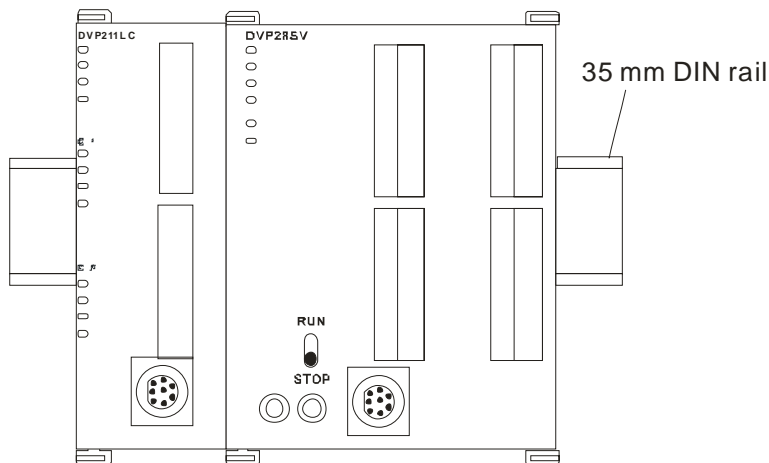

### 3.2 Communication

- Please wire a load cell module according to the definitions of the pins in a communication connector.

PC COM Port 9 PIN D-SUB female		↔	DVP211LC COM Port 8 PIN MINI DIN	
Rx	2	↔	5	Tx
Tx	3	↔	4	Rx
GND	5	↔	8	GND
	7		1,2	5V
	8			
	1			
	4			
	6			

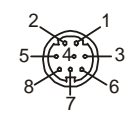

3

- There are 2 communication interfaces in a load cell module which can communicate with a PC or other devices. COM1 is an RS-232 port, and COM2 is an RS-485 port. Both ports meet the standard MODBUS protocol. A PC can directly communicate with a load cell module through COM1.
- Delta power supply modules are highly recommended.

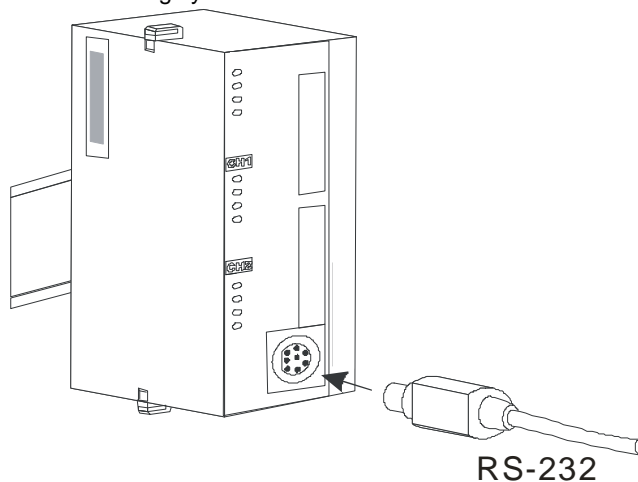

### 3.3 External Wiring

3

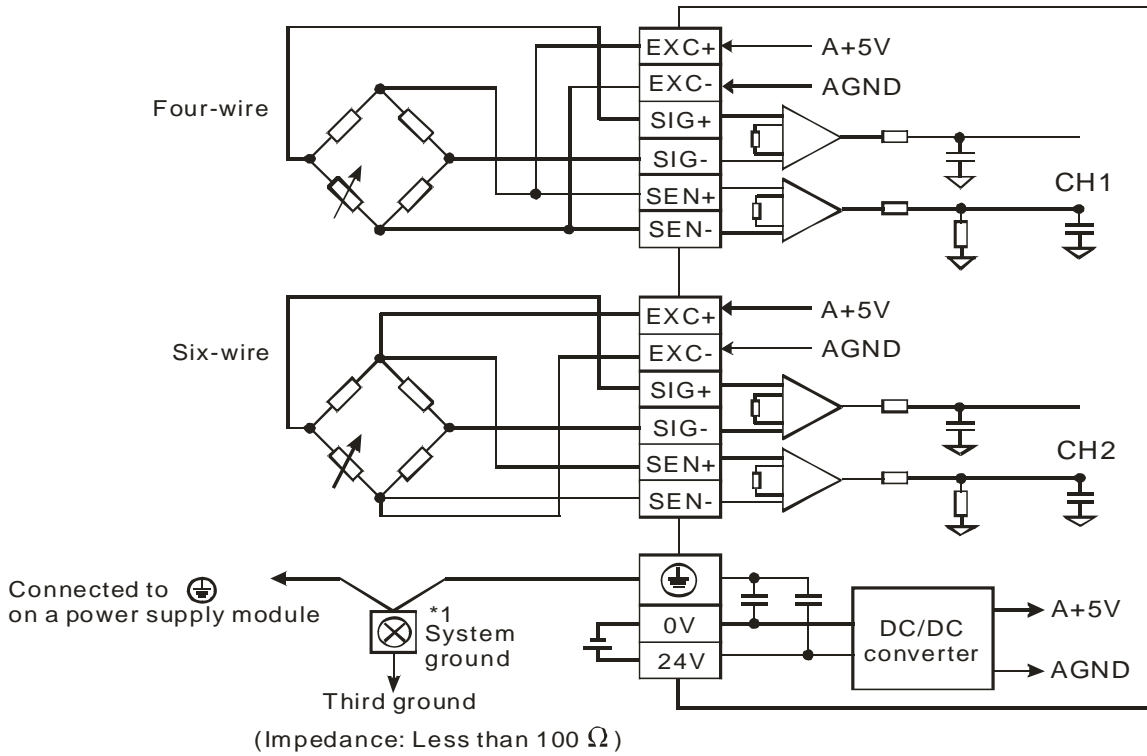

- Multiple load cells connected in parallel are connected to a single load cell module.

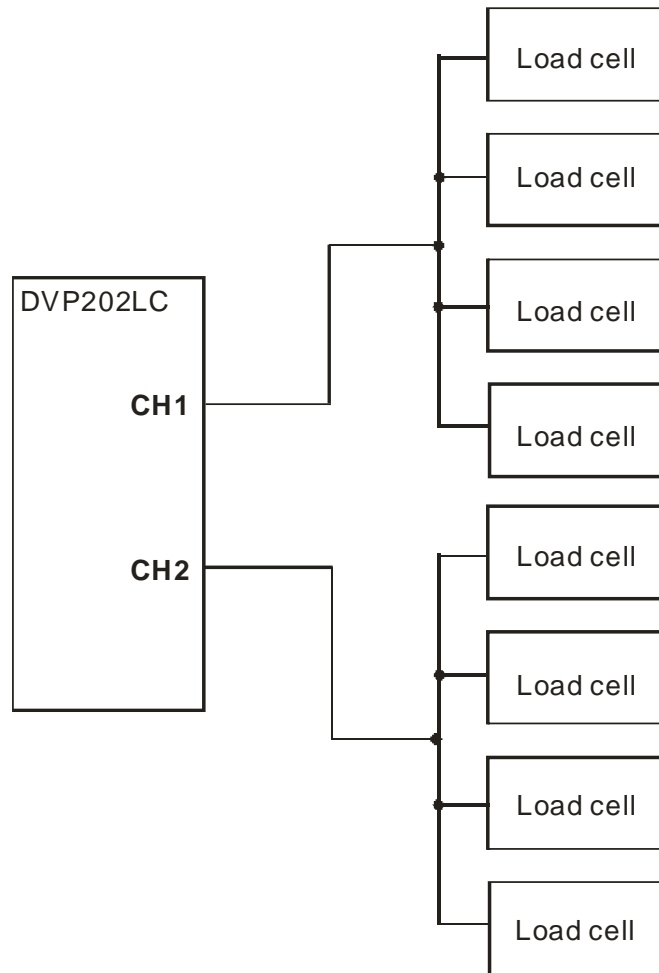

Note 1: Please connect  $\text{⏏}$  on a power supply module and  $\text{⏏}$  on the load cell module to a system ground, and then ground the system ground or connect the system ground to a distribution box.

Note 2: If multiple load cells are connected in parallel, the total impedance should be greater than 40  $\Omega$ .



### 3.4 Selecting a Load Cell Sensor

1. Exciting voltage:

An excitation voltage is external power provided for a load cell sensor. The maximum voltage that a sensor can accept is specified in the specifications for the sensor. The exciting voltage that a load cell module provides is +5 V, and therefore a sensor which can accept a voltage greater than 5 V can be used.

2. Eigenvalue

A load cell sensor uses a bridge circuit. If a load cell is under pressure, SIG+ and SIG- will output voltages which are in proportion to force. An eigenvalue determines the characteristics of the output of a load cell sensor. The unit used is mV/V. If a load cell receives external force, it will output low voltage.

Output a sensor:  $(\text{Force}/\text{Maximum rated load}) \times (\text{Exciting voltage} \times \text{Eigenvalue})$

Example: The eigenvalue of a sensor is 2 mV/V, and the maximum rated load of the sensor is 10 kg. The voltage provided by a module is 5 V. The voltage to which the maximum rated load corresponds is 10 mV. If the load of the sensor is 1 kg, the voltage that the sensor outputs will be 1 mV. The eigenvalue that the module can support is 80 mV/V. The sensors whose eigenvalues are less than 80 mV/V can be used.

3. Maximum rated load

When users select a load cell module, they have to consider factors such as loads, tares, vibrations, and shocks. The closer the load on a load cell sensor is to the maximum rated load specified in the specifications for the load cell sensor, the more accurately the load is measured.

4. Four-wire configuration/Six-wire configuration

There are two ways to wire a load cell sensor. They are a four-wire configuration and a six-wire configuration. A load cell module provides power for a load cell sensor by means of EXC+/EXC-. However, there is impedance between the load cell module and the sensor. The voltage that the sensor actually receives is less than the voltage provided by the module. The output terminals SIG+ and SIG- on a sensor have relations with the voltages received. If the distance between a module and a sensor is short, the impedance between the module and the sensor will be small, and a four-wire configuration can be adopted. If the distance between a module and a sensor is long, a six-wire configuration can be used to reduce the error resulting from the impedance between the module and the sensor.

5. Estimating precision

The precision of a load cell module is 0.04%. The maximum rated load of a load cell sensor multiplied by 0.04% is the maximum precision that a load cell module can resolve. (The measurement time set by default is 50 milliseconds.) If the measurement time set is longer, the precision presented will increase. When users select a load cell sensor, they have to check whether the conversion time of the load cell sensor and the precision of the load cell sensor meet their requirements.



# 4

## Chapter 4 Control Registers

### Table of Contents

4.1	Table of Control Registers.....	4-2
4.2	Descriptions of the Control Registers .....	4-5
4.3	Descriptions of Functions .....	4-9
4.3.1	Measuring a Net Weight .....	4-9
4.3.2	Stability Check .....	4-10
4.3.3	Determining Zero.....	4-11
4.3.4	Filtering out Weights .....	4-11
4.3.5	Correspondence between Current Outputs and Weights .....	4-12

## 4.1 Table of Control Registers

4

CR#	Address	Attribute		Register name	Explanation
#0	H1000	O	R	Model name	The model code of a load cell module is defined by the module's system. DVP201LC-SL's model code=H'5106 DVP202LC-SL's model code=H'5206 DVP211LC-SL's model code=H'5906
#1	H1001	O	R	Firmware version	Hexadecimal value The current firmware version of a load cell module is displayed.
#2	H1002	O	R/W	Characteristic value	CH1: Bit 0~bit 7; CH2: Bit 8~bit 15 Mode 0: 1 mV/V; Mode 4: 20 mV/V Mode 1: 2 mV/V; Mode 5: 40 mV/V Mode 2: 4 mV/V; Mode 6: 80 mV/V Mode 3: 6 mV/V
#3	H1003	O	R/W	Reaction time for measurement	CH1: bit0~bit7; CH2: bit8~bit15 Mode 0: 2.5ms; Mode 5: 60ms Mode 1: 10ms; Mode 6: 100ms Mode 2: 16ms; Mode 7: 200ms Mode 3: 20ms; Mode 8: 400ms Mode 4: 50ms (factory setting)
#6	H1006	X	R/W	Returning to zero/Subtracting a tare	K1: Subtracting the tare measured by CH1 K2: Not subtracting the tare measured by CH1 K3: Restoring the weight measured by CH1 to zero K4: Subtracting the tare measured by CH2 K5: Not subtracting the tare measured by CH2 K6: Restoring the weight measured by CH2 to zero
#7	H1007	O	R/W	Displaying a gross weight/net weight	CH1: Bit 0~bit 7; CH2: Bit 8~bit 15 K0: Displaying a gross weight K1: Displaying a net weight
#8	H1008	O	R/W	Tare measured by CH1 (Low word)	Displaying a tare
#9	H1009	O	R/W	Tare measured by CH1 (High word)	
#10	H100A	O	R/W	Tare measured by CH2 (Low word)	
#11	H100B	O	R/W	Tare measured by CH2 (High word)	
#12	H100C	X	R	Weight measured by CH1 (Low word)	Displaying a weight
#13	H100D	X	R	Weight measured by CH1 (High word)	
#14	H100E	X	R	Weight measured by C2 (Low word)	
#15	H100F	X	R	Weight measured by C2 (High word)	
#16	H1010	O	R/W	Number of weights measured by CH1 in a stability range	Setting range: K1~K500 (Factory setting: K5)
#17	H1011	O	R/W	Number of weights measured by CH2 in a stability range	Setting range: K1~K500 (Factory setting: K5)
#18	H1012	O	R/W	Stability range for CH1	Setting range: K1~K10000 (Factory setting: K10)
#19	H1013	O	R/W	Stability range for CH2	Setting range: K1~K10000 (Factory setting: K10)

CR#	Address	Attribute		Register name	Explanation
#25	H1019	O	R/W	Total number of points which need to be adjusted	Setting range: K2~K20 (Factory setting: K2)
#26	H101A	X	R/W	Adjustment command	CH1: K1~K20 CH2: K21~K40
#27	H101B	O	R/W	Selecting a point which needs to be adjusted for CH1	K1~K19
#28	H101C	O	R/W	Selecting a point which needs to be adjusted for CH2	K1~K19
#29	H101D	O	R/W	Digital value given to a point which needs to be adjusted for CH1 (Low word)	Digital value given to a point which needs to be adjusted
#30	H101E	O	R/W	Digital value given to a point which needs to be adjusted for CH1 (High word)	
#31	H101F	O	R/W	Digital value given to a point which needs to be adjusted for CH2 (Low word)	Digital value corresponding to a weight needs to be adjusted
#32	H1020	O	R/W	Digital value given to a point which needs to be adjusted for CH2 (High word)	
#33	H1021	O	R/W	Weight of a point which needs to be adjusted for CH1 (Low word)	Weight of a weight
#34	H1022	O	R/W	Weight of a point which needs to be adjusted for CH1 (High word)	
#35	H1023	O	R/W	Weight of a point which needs to be adjusted for CH2 (Low word)	
#36	H1024	O	R/W	Weight of a point which needs to be adjusted for CH2 (High word)	
#37	H1025	O	R/W	Maximum which can be measured by CH1 (Low word)	Users can specify the maximum weight which can be measured by CH1/CH2. If a weight measured exceeds the maximum weight, an error code will be stored.
#38	H1026	O	R/W	Maximum which can be measured by CH1 (High word)	
#39	H1027	O	R/W	Maximum which can be measured by CH2 (Low word)	
#40	H1028	O	R/W	Maximum which can be measured by CH2 (High word)	
#41	H1029	X	R/W	Storing all setting values (H'5678)	Storing all setting values, and writing them to the flash memory in the load cell module used H0: No action (factory setting) H'FFFF: All setting values are stored successfully. H'5678: Writing all setting values to the flash memory in the load cell module used

CR#	Address	Attribute	Register name	Explanation
CR#41: If the value in CR#41 is H'5678, all setting values will be stored in the flash memory. After the setting values are stored, the value in CR#41 will become H'FFFF. If the value written to CR#41 is not H'5678, it will automatically become H'0. For example, if H1 is written to CR#41, it will become H1. (After the adjustment of points is complete, please use CR#41 to make adjustment parameters retentive.)				
#42	H102A	X R/W	Restoring all settings to factory settings	Restoring all settings to factory settings (H'55AA)
#43	H102B	X R/W	Way in which weights measured by CH1 are filtered out	K0: Not filtering weights (factory setting) K1: Filtering out the maximum weight measured K2: Averaging weights
#44	H102C	X R/W	Way in which weights measured by CH2 are filtered out	
#45	H102D	X R/W	Filter parameter for CH1	Filtering out the maximum weight measured: K0~K8 Averaging weights: The number of weights which need to be averaged should be in the range of K1 to K100.
#46	H102E	X R/W	Filter parameter for CH1	
#48	H1030	O R/W	Range for determining whether the digital value corresponding to a weight measured by CH1 is 0 grams	If the digital value corresponding to a weight measured by CH1/CH2 is in the range specified, bit 5/bit 10 in CR#51 will be set (the weight measured is will be counted as 0 grams). Default value: K10 Setting range: K0~K32767
#49	H1031	O R/W	Range for determining whether the digital value corresponding to a weight measured by CH2 is 0 grams	
#51	H1033	X R/W	Status code	The status of the load cell module used is stored in this register. Please refer to the status table below for more information. Factory setting: H'0000
#52	H1034	O R/W	RS-232 station address	The default value in CR#52/CR#54 is K1. The setting values in CR#52 and CR#54 should be in the range of K1 to K255. The default value in CR#53/CR#55 is H'0000 (ASCII, 9600 bps, 7 data bits, even parity bit, one stop bit). Please refer to the communication format table below for more information.
#53	H1035	O R/W	RS-232 communication format	
#54	H1036	O R/W	RS-485 station address	
#55	H1037	O R/W	RS-485 communication format	
#100	H1064	X R/W	Current output	Setting range: K0~K4000
#101	H1065	X R	Digital input terminal	Bit 0: X0; Bit 1: X1
#102	H1066	X R/W	Digital output terminal	Bit 0: Y0; Bit 1: Y1; Bit 2: Y2; Bit 3: Y3
#103	H1067	O R/W	Way of outputting a current	K0: Digital value corresponding to a current output in the range of 0 mA to 20 mA (factory setting) K1: Digital value corresponding to a current output in the range of 4 mA to 20mA K2: Weight corresponding to a current output in the range of 0 mA to 20mA K3: Weight corresponding to a current output in the range of 4 mA to 20mA

CR#	Address	Attribute		Register name	Explanation
#104	H1068	O	R/W	Way in which a digital input terminal operates	X0: Bit 0~bit 7; X1: Bit 8~bit 15 H0: General digital input terminal (factory setting) H1: If a digital input terminal is ON, a weight will be restored to zero, H2: If a digital input terminal is ON, a tare will be measured. H3: If a digital input terminal is ON, a tare will be subtracted. H4: If a digital input terminal is OFF, a net weight will be measured. If a digital input terminal is ON, a gross weight will be measured. H6: If a digital input terminal is ON, zero will be adjusted. H7: If a digital input terminal is ON, the first point will be adjusted. X0 and X1 can not be set to H4 simultaneously.
#105	H1069	O	R/W	Way in which a digital output terminal operates	<b>Bit 15~bit 12</b> <b>Bit 11~bit 8</b> <b>Bit 7~bit 4</b> <b>Bit 3~bit 0</b> <b>Y3</b> <b>Y2</b> <b>Y1</b> <b>Y0</b>
					H0: General digital output terminal (factory setting) H1: If no weight is measured, a digital output terminal will be ON. H2: If no weight is measured, a digital output terminal will be OFF. H3: If a weight measured is greater than the maximum weight specified, a digital output terminal will be ON. H4: If a weight measured is greater than the maximum weight specified, a digital output terminal will be OFF. H5: If an excitation voltage is abnormal, a digital output terminal will be ON. H6: If an excitation voltage is abnormal, a digital output terminal will be OFF. H7: If a weight measured is in the stability range specified, a digital output terminal will be ON. H8: If a weight measured is in the stability range specified, a digital output terminal will be OFF.
Symbols: O: Retentive register X: Unretentive register R: Users can read data. W: Users can write data.					



## 4.2 Descriptions of the Control Registers

<b>CR#0:</b> Model name [Description] DVP201LC-SL's model code=H'5106 DVP202LC-SL's model code=H'5206 DVP211LC-SL's model code=H'5906
---

**CR#1:** Firmware version

[Description]

High byte: Number at the left side of the decimal point in a version number

Low byte: Number at the right side of the decimal point in a version number

Example: V1.01 → CR#=H'0101

**CR#2:** Eigenvalue

[Description]

The specifications for load cells vary from brand to brand. Users need to set an eigenvalue according to the specification for the load cell used.

Eigenvalue		
Specifications for the eigenvalue in a load cell	Selection of an eigenvalue	Setting value in CR#2
0mV/V < Eigenvalue ≤ 1 mV/V	1m V/V	H'0000
1mV/V < Eigenvalue ≤ 2 mV/V	2m V/V	H'0001 (Default setting)
2mV/V < Eigenvalue ≤ 4 mV/V	4m V/V	H'0002
4mV/V < Eigenvalue ≤ 6 mV/V	6m V/V	H'0003
6mV/V < Eigenvalue ≤ 20 mV/V	20m V/V	H'0004
20mV/V < Eigenvalue ≤ 40 mV/V	40m V/V	H'0005
40mV/V < Eigenvalue ≤ 80 mV/V	80m V/V	H'0006
Eigenvalue > 80 mV/V	Not supported	

**CR#3:** Reaction time for measurement

[Description]

Users can set the time which needs to elapse before a weight is sampled. The shorter the time set is, the shorter the time it takes to filter weights. The weights measured are not in a stability range. If the time set is the maximum time which can be set, the weights measure will be in a stability range.

Reaction time for measurement	
Input value	Description
Mode 0: H'0000	2.5 ms
Mode 1: H'0001	10 ms
Mode 2: H'0002	16 ms
Mode 3: H'0003	20 ms
Mode 4: H'0004	50ms (Default setting)
Mode 5: H'0005	60 ms
Mode 6: H'0006	100 ms
Mode 7: H'0007	200 ms
Mode 8: H'0008	400 ms

**CR#6:** Returning to zero/Subtracting a tare

[Description]

Users can use CR#6 to restore the weight measured to zero.

Input value	Description
K1	Subtracting the tare measured by CH1
K2	Not subtracting the tare measured by CH1
K3	Restoring the weight measured by CH1 to zero
K4	Subtracting the tare measured by CH2
K5	Not subtracting the tare measured by CH2
K6	Restoring the weight measured by CH2 to zero

**CR#7**: Displaying a gross weight/net weight

[Description]

Users can choose to display a gross weight or a net weight. The channel which is not used can be disabled.

Bit 15~bit 8	Bit 7~bit 0
CH2	CH1
K0: Displaying a gross weight K1: Displaying a net weight	

**CR#8~11**: Tare measured by CH1/CH2

[Description]

Tares are displayed in CR#8~CR#11. Users can write tares to CR#8~CR#11, or use CR#8~CR#11 to read tares.

**CR#12~15**: Weight measured by CH1/CH2

[Description]

Weights are displayed in CR#12~CR#15.

**CR#16~17**: Number of weights measured by CH1 in a stability range

[Description]

Factory setting: K5

Setting range: K1~K500

Please refer to section 4.3.2 for more information.

**CR#18~19**: Stability range for CH1/CH2

[Description]

Factory setting: K10

Setting range: K1~K10,000

Please refer to section 4.3.2 for more information.

**CR#25**: Total number of points which need to be adjusted

[Description]

Factory setting: K2

Setting range: K2~K20

Users generally adjust two points, but they can adjust several points. The maximum number of points which can be adjusted is 20.

**CR#26**: Adjustment command

[Description]

An adjustment command is stored in CR#26.

Command value	Description of CR#26
K1~K20	K1: The command value is used when no weight is measured by CH1. K2~K20: The command values are used when point 1~point 19 which are measured by CH1 need to be adjusted.
K21~40	K21: The command value is used when no weight is measured by CH2. K22~K40: The command values are used when point 1~point 19 which are measured by CH2 need to be adjusted.



**CR#27~28:** Selecting a point which needs to be adjusted for CH1/CH2

[Description]

Command value	Description
K1~K19	Selecting point 1~point 19 for CH1
K1~K19	Selecting point 1~point 19 for CH2

**CR#29~32:** Digital value given to a point which needs to be adjusted for CH1/CH2

[Description]

The digital values given to points which need to be adjusted are displayed in CR#29~CR#32.

**CR#33~36:** Weight of a point which needs to be adjusted for CH1/CH2

[Description]

The weights of points which need to be adjusted are written to CR#33~CR#36.

**CR#37~40:** Maximum weight which can be measured by CH1/CH2

[Description]

Users can specify the maximum weight which can be measured by CH1/CH2. If the weight measured by CH1/CH2 exceeds the maximum weight specified, bit 4/bit 9 in CR#51 will be set to 1.

**CR#41:** Storing all setting values

[Description]

CR#41 is used to store all setting values, and write them to the flash memory in the load cell module used. Factory setting: 0

If the value in CR#41 is H'5678, all setting values will be stored in the flash memory in the load cell module used. After the setting values are stored, the value in CR#41 will become H'FFFF. If the value written to CR#41 is not H'5678, it will automatically become H'0. For example, if H'1 is written to CR#41, it will become H'0.

Description	H'0	H'FFFF	H'5678
Setting	No action	All setting values are stored successfully.	Writing all setting values to the flash memory in the load cell module used

**CR#43~44:** Way in which weights measured by CH1/CH2 are filtered out

[Description]

Users can set a way in which weights measured by CH1/CH2 are filtered out according to their requirements.

K0: Not filtering weights (factory setting)

K1: Filtering out the maximum weight measured

K2: Averaging weights

**CR#45~46:** Filter parameter for CH1/CH2

[Description]

Filtering out the maximum weight measured: K0~K8

Averaging weights: The number of weights which need to be averaged should be in the range of K1 to K100.

**CR#48~49:** Range for determining whether the digital value corresponding to a weight measured by CH1/CH2 is 0 grams

[Description]

If the digital value corresponding to a weight measured by CH1/CH2 is in the range specified, bit 5/bit 10 in CR#51 will be set to 1.



**CR#51:** Status code

[Description]

Bit number	Value	Description
Bit 0	H'0001	Abnormal power
Bit 1	H'0002	Hardware failure
Bit 2	H'0004	The weight measured by CH1 exceeds the maximum weight which can be measured, or the voltage of SEN is incorrect.
Bit 3	H'0008	CH1 is adjusted incorrectly.
Bit 4	H'0010	The weight measured by CH1 exceeds the maximum weight which can be measured.
Bit 5	H'0020	No weight is measured by CH1.
Bit 6	H'0040	A weight measured by CH1 is in the stability range specified.
Bit 7	H'0080	The conversion of a weight measured by CH2 into a digital value is incorrect, or the voltage of SEN is incorrect.
Bit 8	H'0100	CH2 is adjusted incorrectly.
Bit 9	H'0200	The weight measured by CH2 exceeds the maximum weight which can be measured.
Bit 10	H'0400	No weight is measured by CH2.
Bit 11	H'0800	A weight measured by CH2 is in the stability range specified.
Bit 12~bit 15		Reserved

**CR#52~55:** Setting RS-232/RS-485 communication

[Description]

Bit 15	Bit 14~Bit 8	Bit 7	Bit 6	Bit 5	Bit 4	Bit 3	Bit 2	Bit 1	Bit 0	
ASCII/RTU	Reserved	Serial transmission speed		Data length		Stop bit	Parity bit			
Description										
Bit 15	ASCII/RTU			0	ASCII		1	RTU		
Bit 7~bit 4	Serial transmission speed			0	9,600 bps		1	19,200 bps		
				2	38,400 bps		3	57,600 bps		
				4	115,200 bps		5	Reserved		
Bit 3	Data length (RTU=8 bits)			0	7		1	8		
Bit 2	Stop bit			0	1 bit		1	2 bits		
Bit 1~bit 0	Parity bit			0	Even		1	Odd		
				2	Reserved		3	Reserved		

Example: If RS-232 communication format is "115200, 7, E, 1, ASCII", the value in CR#53 will be H'0400.

## 4.3 Descriptions of Functions

### 4.3.1 Measuring a Net Weight

Users can choose to measure the net weight or the gross weight of an object. A net weight is the weight of a product, that is, the actual weight of a product without its package. The weight of a package is a tare. A gross weight is a total weight, namely a net weight plus a tare.

- Tare: A tare is the weight of a package
- Net weight: A net weight is the weight of a product, that is, the actual weight of a product without its package.
- Gross weight: A gross weight is a total weight, namely the weight of a product itself (a net weight) plus the weight of a package (a tare).
- Gross weight=Net weight+Tare

Example: A product weighs 10 kilograms, and the carton in which the product is packed weighs 0.2 kilograms. The total weight gotten is 10 kilograms.

Net weight=10 kg

Tare=0.2 kg

Gross weight=10.2 kg

- Relevant control registers
  - CR#6: Returning to zero/Subtracting a tare
  - CR#7: Displaying a gross weight/net weight
  - CR#8~11: Tare measured by CH1/CH2

### 4.3.2 Stability Check

When an object is put on a load cell, users can check whether the present weight of the object is in a stability range specified.

- If a weight measured is in a stability range specified by users (CR#18/CR#19), bit 6/bit 11 in CR#51 will be set to 1.
- If a weight measured exceeds a range specified by users (CR#18/CR#19), bit 6/bit 11 in CR#51 will be set to 0. Bit 6/Bit 11 in CR#51 will not be set to 1 until the number of weights measured in a stability range reaches the value in CR#16/CR17.

Example: The measurement time set is 10 milliseconds, the number of weights measured in a stability range is 10, and the stability range set is 1000 grams. If a variation exceeds 1000 grams, bit 6/bit 11 in CR#51 will be set to 0. If the variations in 100 milliseconds (10×10 ms) are within 1000 grams, bit 6/bit 11 in CR#51 will be set to 1. (Users should judge whether the present weight measured is in the stability range set before they perform control.)

4

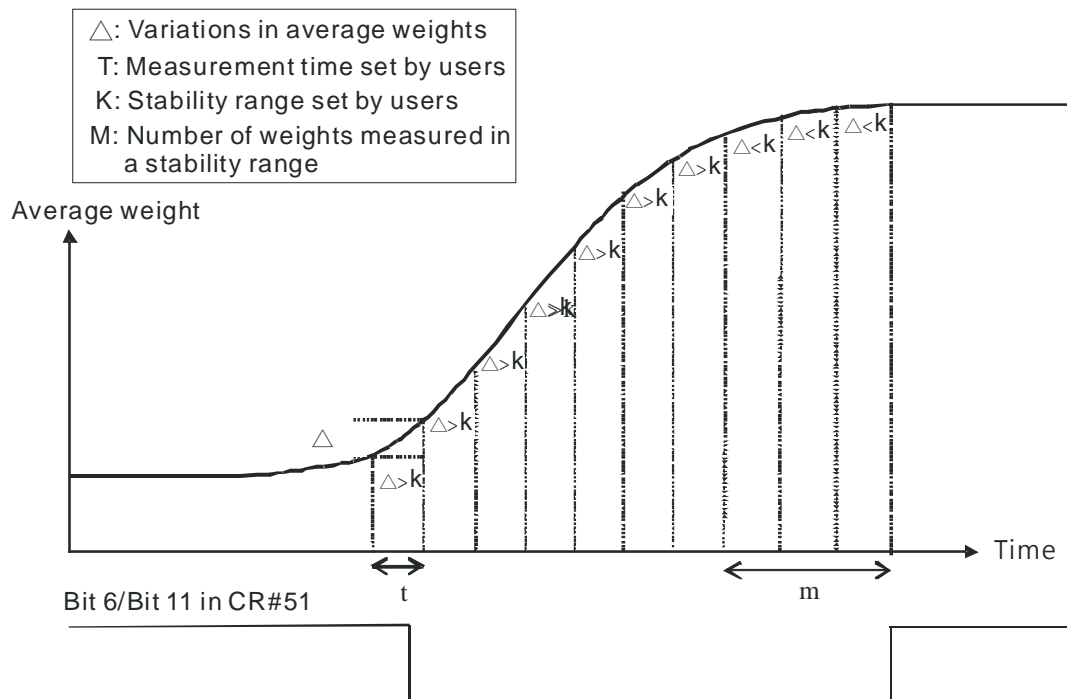

- Relevant control registers
  - CR#16/CR#17: Number of weights measured by CH1/CH2 in a stability range
  - CR#18/CR#19: Stability range for CH1/CH2

### 4.3.3 Determining Zero

If an object is removed from the load cell used, bit 6/bit 11 in CR#51 will be set to 1, bit 5/bit 10 in CR#51 will be set to 1, and users can perform the next control. (If a weight measured is in the zero range specified, bit 5/bit 10 in CR#51 will be set to 1.)

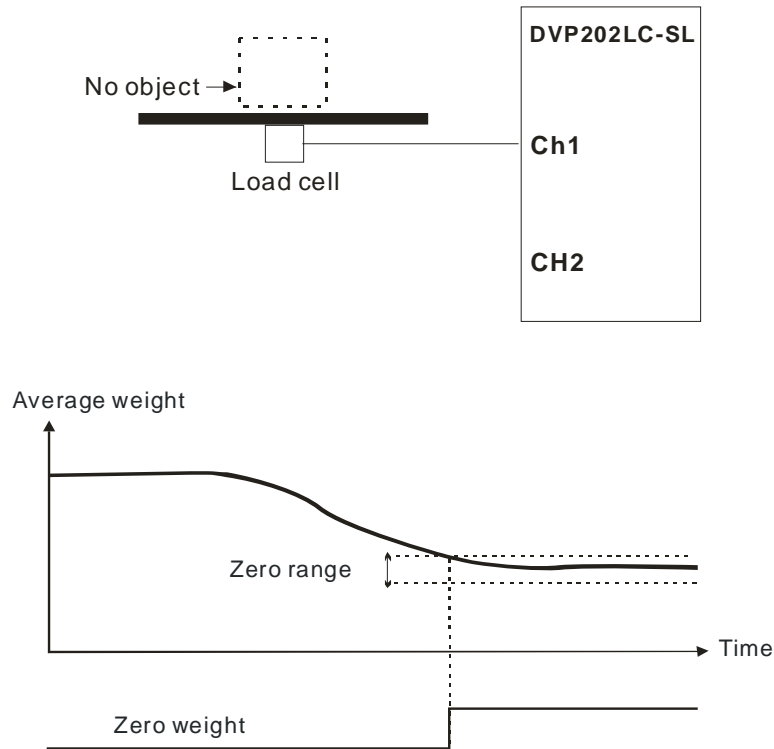

- Relevant control registers
  - CR#48/CR#49: Range for determining whether a weight measured by CH1/CH2 is 0 grams

### 4.3.4 Filtering out Weights

There are two ways to filter out weights.

- Filtering out the maximum/minimum weight measured: If there is a maximum weight or a minimum weight, CR#45/CR#46 can be used to filter out the maximum weight or the minimum weight. If the value in CR#45/CR#46 is bigger, more weights will be filtered out. Setting range: K0~K8
- Averaging weights: The values read are averaged so that a steady value is obtained. There may be peak values due to unavoidable external factors, and the average value obtained changes accordingly. The maximum number of values which can be averaged are 100.

### 4.3.5 Correspondence between Current Outputs and Weights

Currents outputs directly correspond to weights. Currents vary with weights. Users can set a current output mode by means of CR#103.

Current output

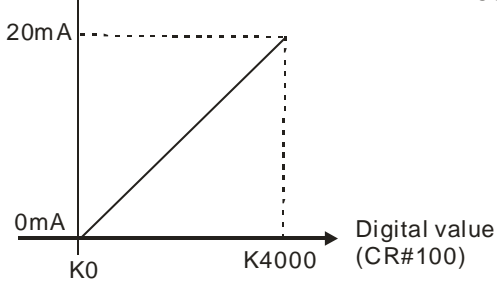

(Mode 0)

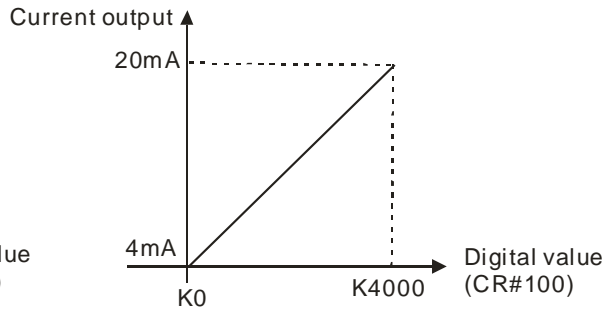

(Mode 1)

4

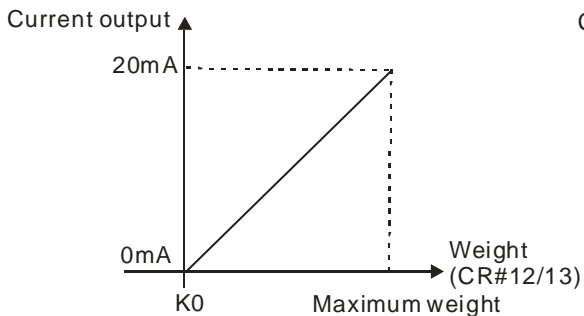

(Mode 2)

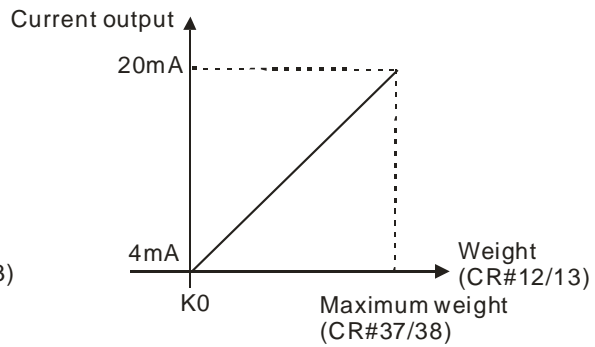

(Mode 3)

Example: 10 kg correspond to 20 mA.

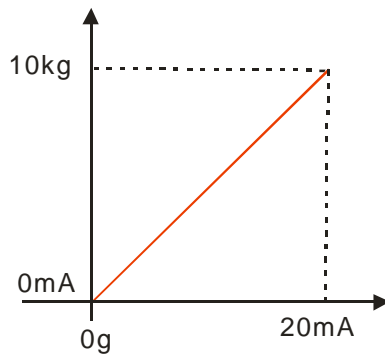

A load cell module is directly connected to the left side of a DVP series PLC. The instruction TO is used to set parameters.

CR#103 is set to K2, and CR#37/CR#38 is set to K10000. Please see the WPLSoft program shown below.

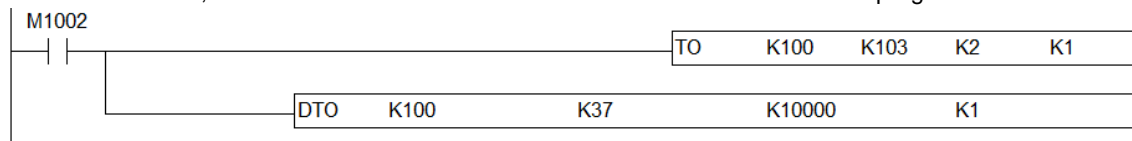

# 5

## Chapter 5 Making Adjustment

### Table of Contents

5.1	Steps in Adjusting Points.....	5-3
5.2	Example 1 .....	5-4
5.3	Example 2 .....	5-5

The purpose of making adjustment is to make the weight measured by a cell correspond to the digital value displayed in a load cell module. Generally, two points are adjusted. After a system is set up, users can put no load on the scale. The weight measured is 0 grams when no load is put on the scale. The users can put a given weight on the scale, and set a digital value corresponding to the weight. The two points are adjusted. For example, if a load cell sensor which can measure a maximum weight of 10 kg is used, and 1 kg correspond to K1000, the curve presented will be like the one shown below.

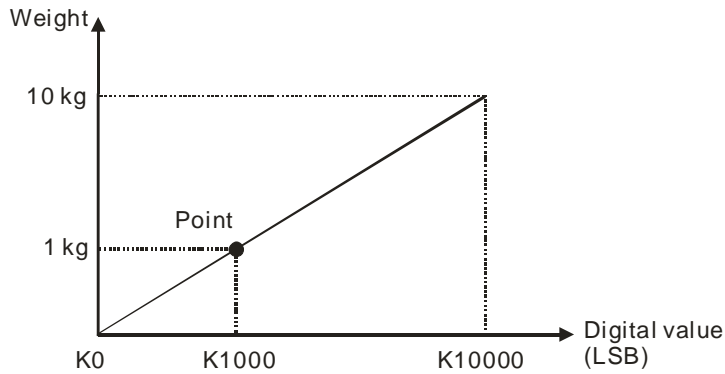

Adjusting two points

In addition to the adjustment of two points, a load cell supports the adjustment of multiple points (20 points at most). A characteristic curve is shown below.

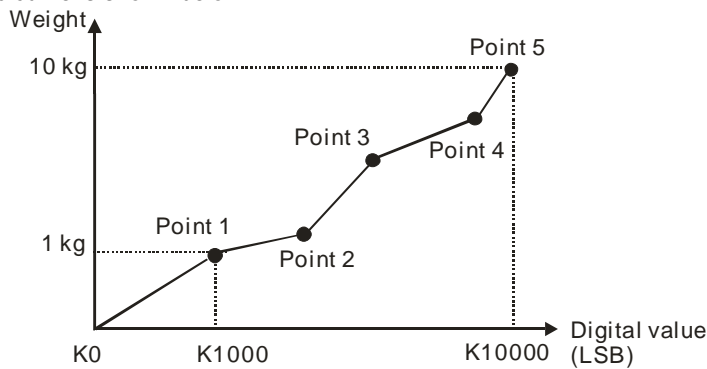

Adjusting multiple points

5

### 5.1 Steps in Adjusting Points

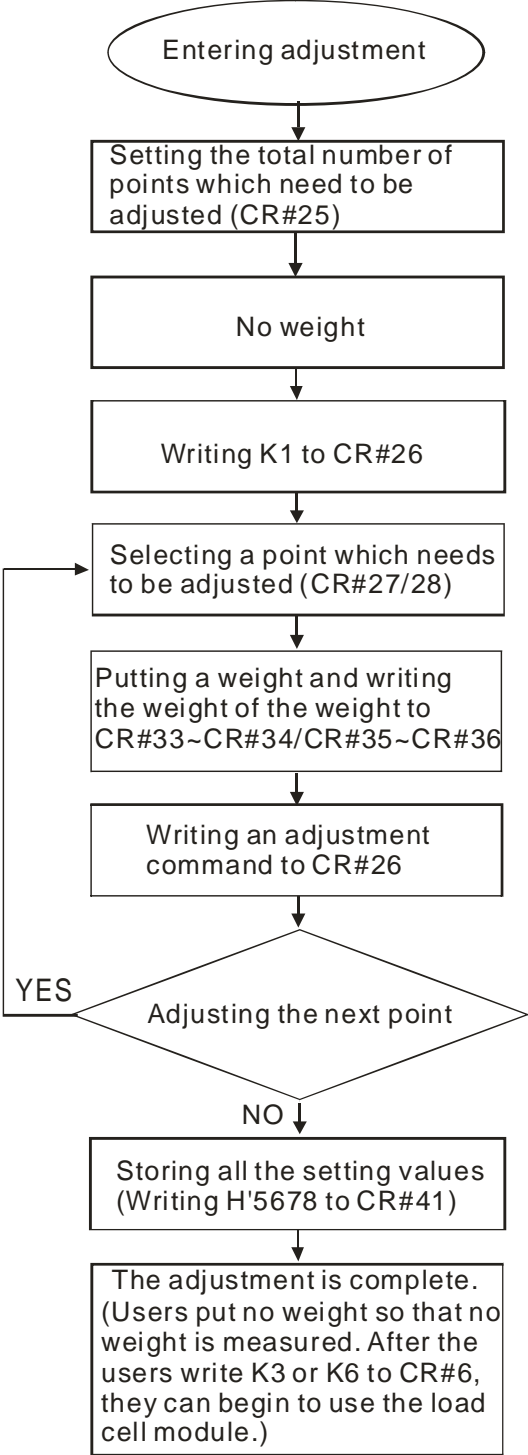



## 5.2 Example 1

Example: One point is adjusted. (A weight which weighs 1 kg corresponds to 1000 lsb.)

A load cell module is directly connected to the left side of a DVP series PLC. The instruction TO is used to make adjustment. The steps in making adjustment are as follows.

Step 1: Write K2 to CR#25. Please see the WPLSoft program shown below.

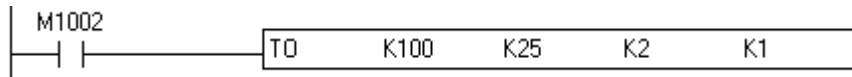

Step 2: Connect a load cell to a module, and put no load on the load cell.



Step 3: Write H'0001 to CR#26. Please see the WPLSoft program shown below.

5

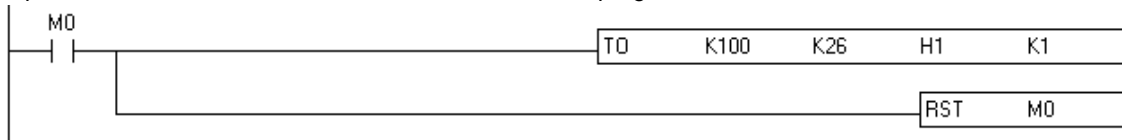

Step 4: Select point 1 (default setting), and write H1 to CR#27. Please see the WPLSoft program shown below.

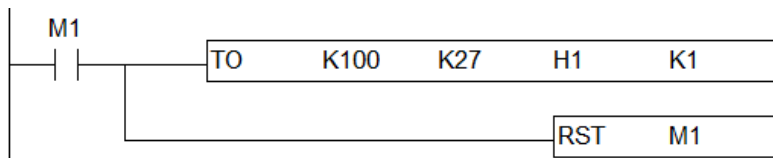

Step 5: Put a standard weight which weighs 1000 g on the load cell.

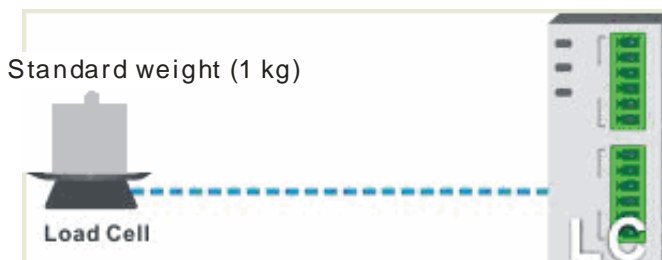

Step 6: Write K1000 (1000 g) to CR#33.

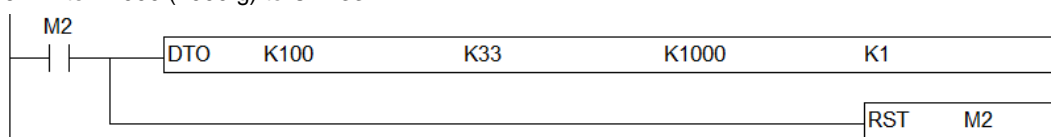

Step 7: Write H2 to CR#26.

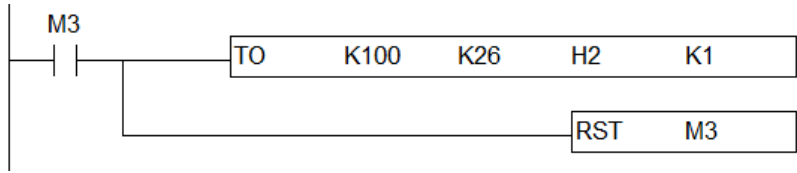

Step 8: Make sure that the value displayed is correct, and make the adjustment retentive. Write H'5678 to CR#41. Please see the WPLSoft program shown below.

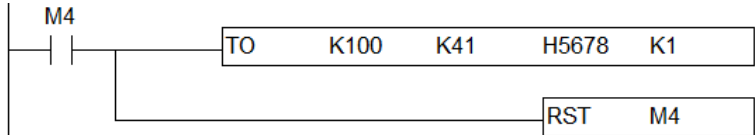

### 5.3 Example 2

Example: Three points are adjusted.

A load cell module is used independently. The steps in making adjustment are as follows.

Step 1: Select **3** in the **The Num. of Adjustment** box. The weight of the first weight is 500 g. It corresponds to 500 lsb. The weight of the second weight is 1000 g. It corresponds to 1000 lsb. The weight of the third weight is 1500 g. It corresponds to 1500 lsb. Please see the figure below.

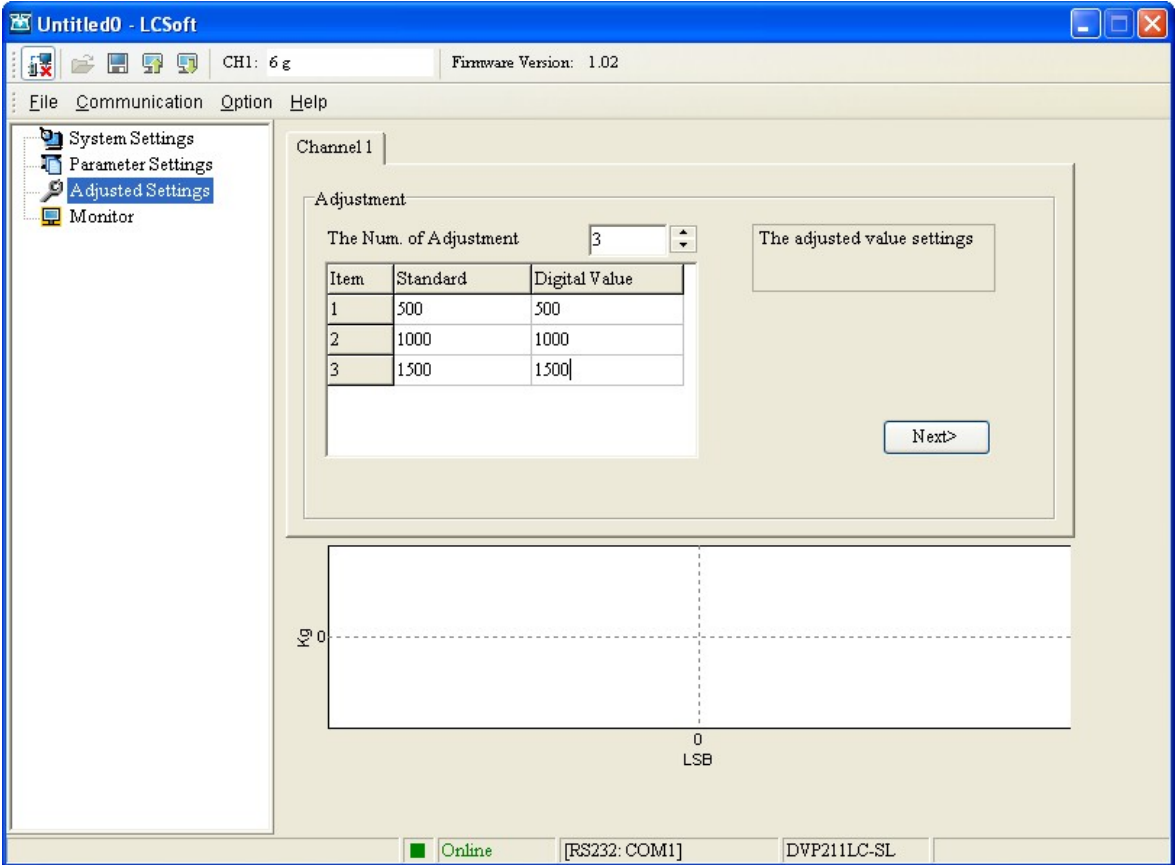

5

Step 2: Put no load on the load cell used. Please see the figures below.

5

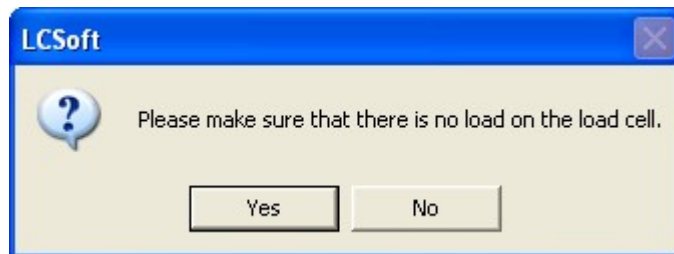
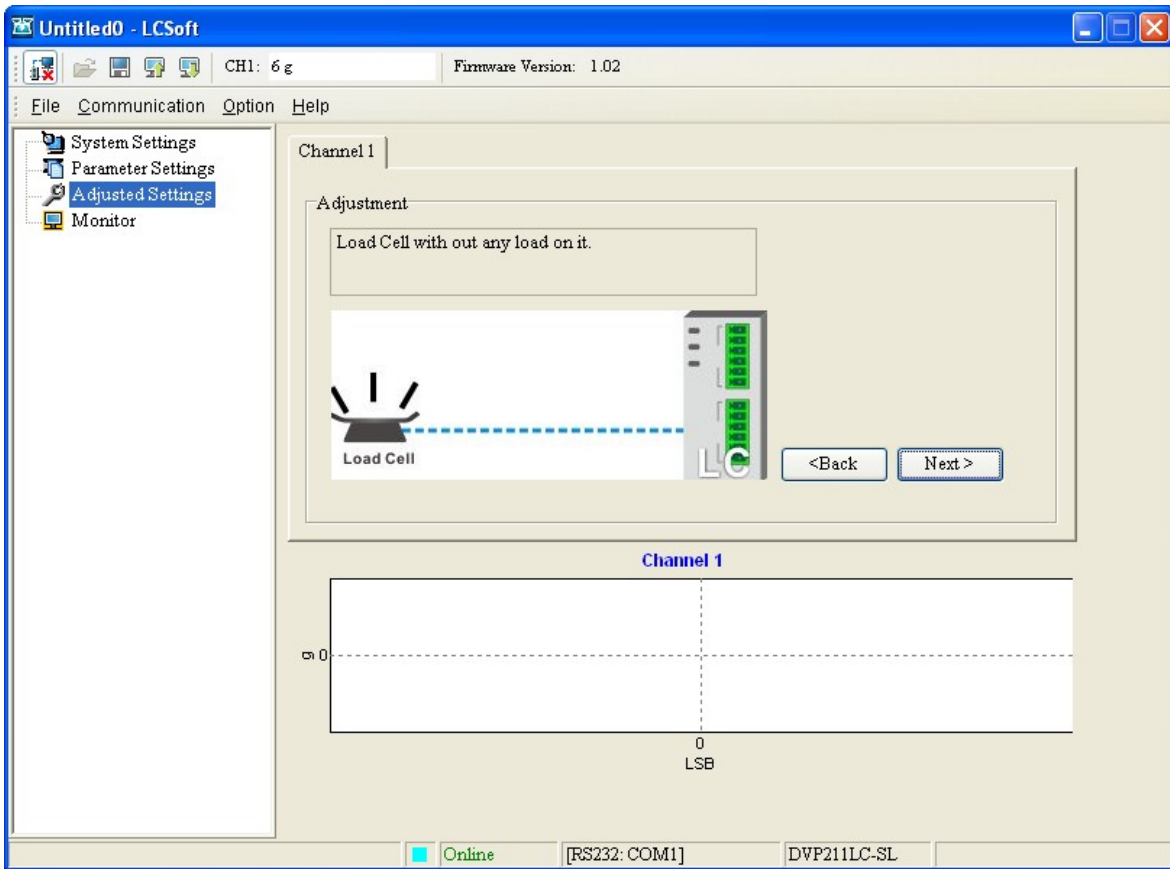

Step 3: Put a standard weight which weighs 500 g on the load cell used, and click **Next**. Please see the figure below.

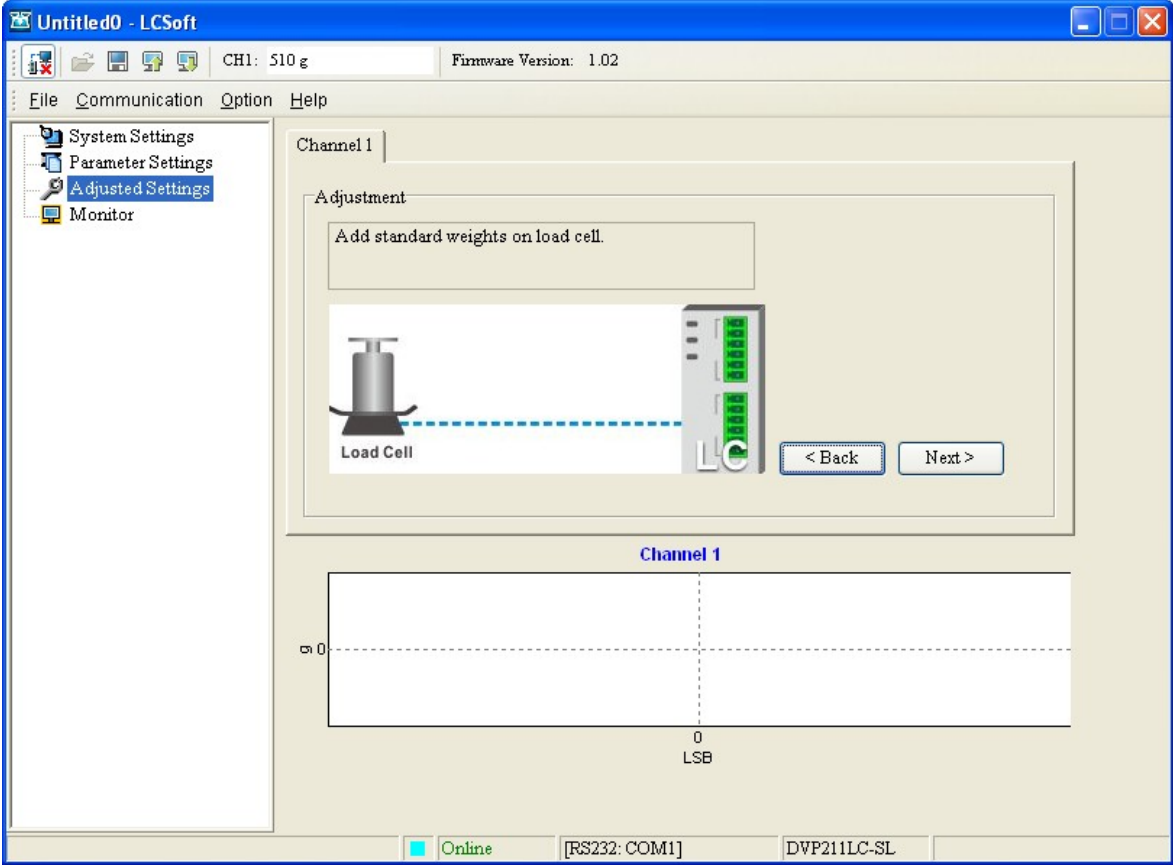

5

Step 4: Type "500" in the **Wight value of weights** box, type "500" in the **Digital value of weights** box, and click **Next**. Please see the figures below.

5

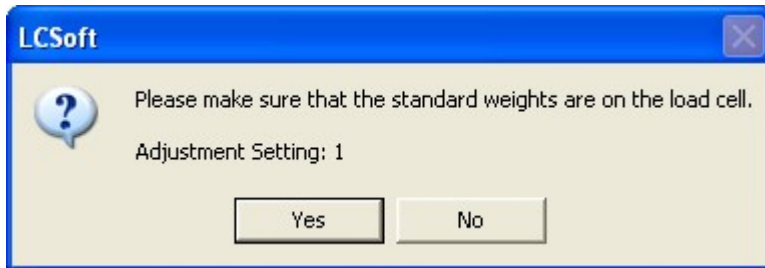
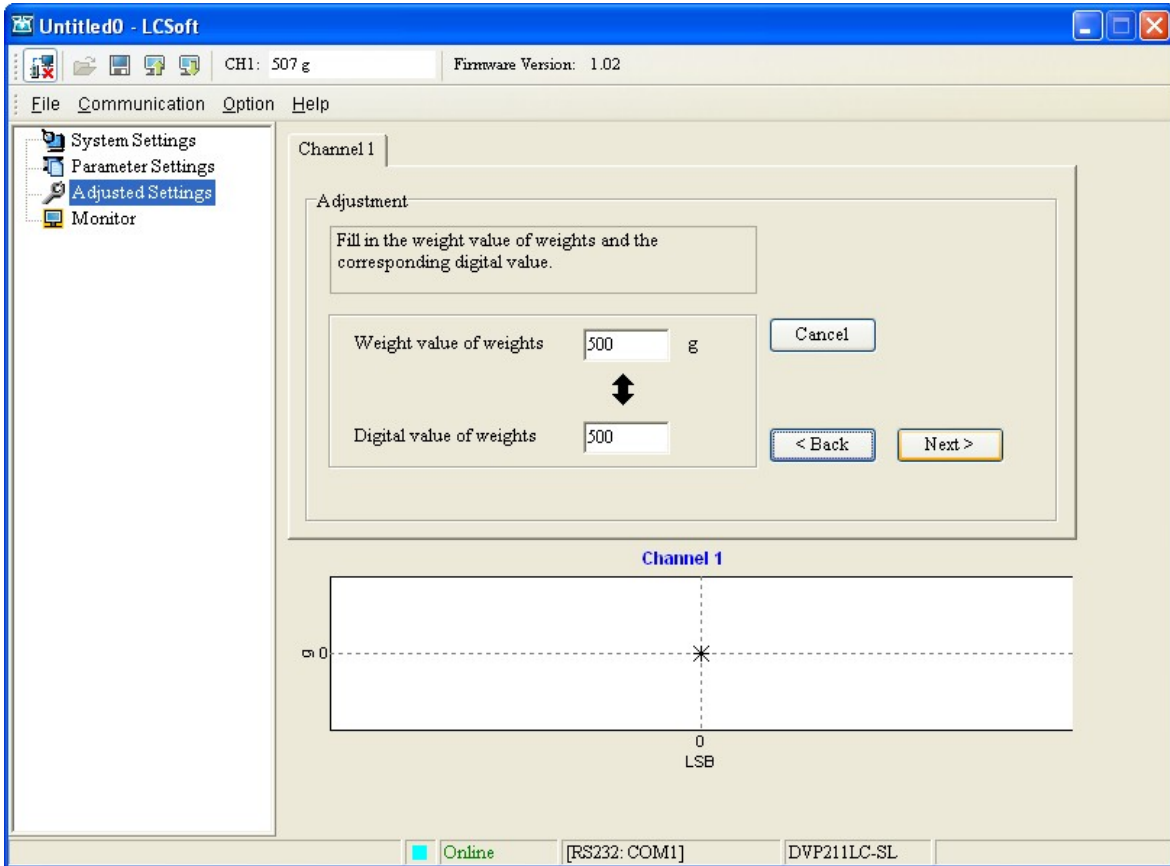

Step 5: Put a standard weight which weighs 1000 g on the load cell used. Type "1000" in the **Wight value of weights** box, type "1000" in the **Digital value of weights** box, and click **Next**. Please see the figures below.

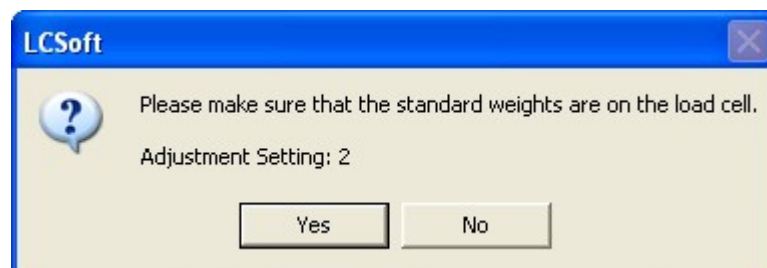
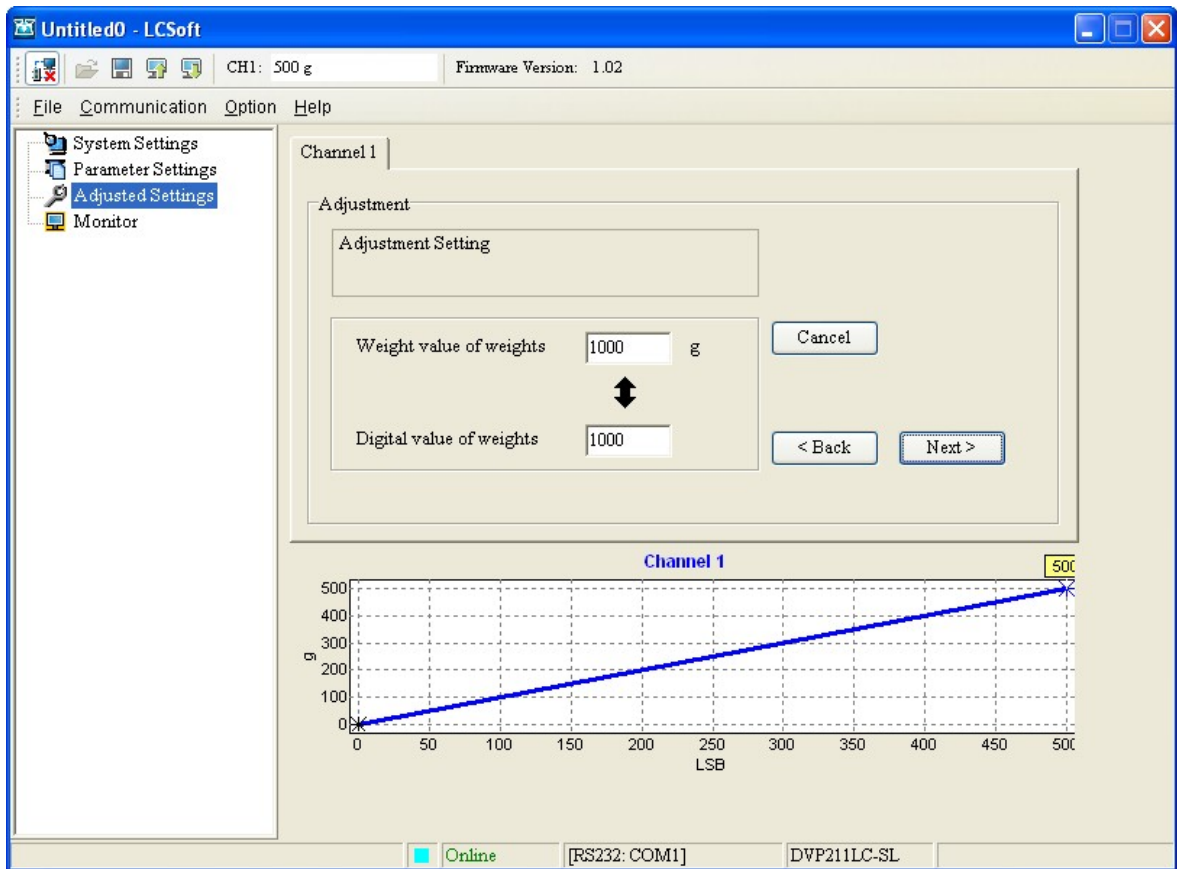

5

Step 6: Put a standard weight which weighs 1500 g on the load cell used. Type “1500” in the **Wight value of weights** box, type “1500” in the **Digital value of weights** box, and click **Next**. Please see the figures below.

5

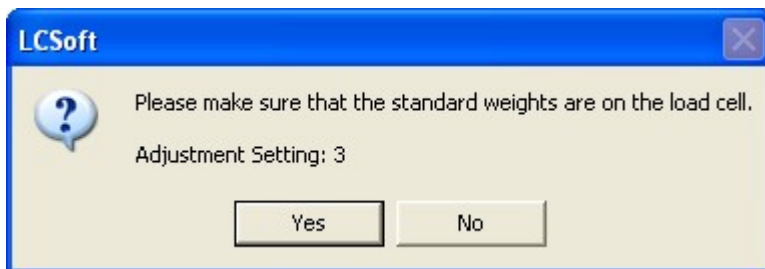
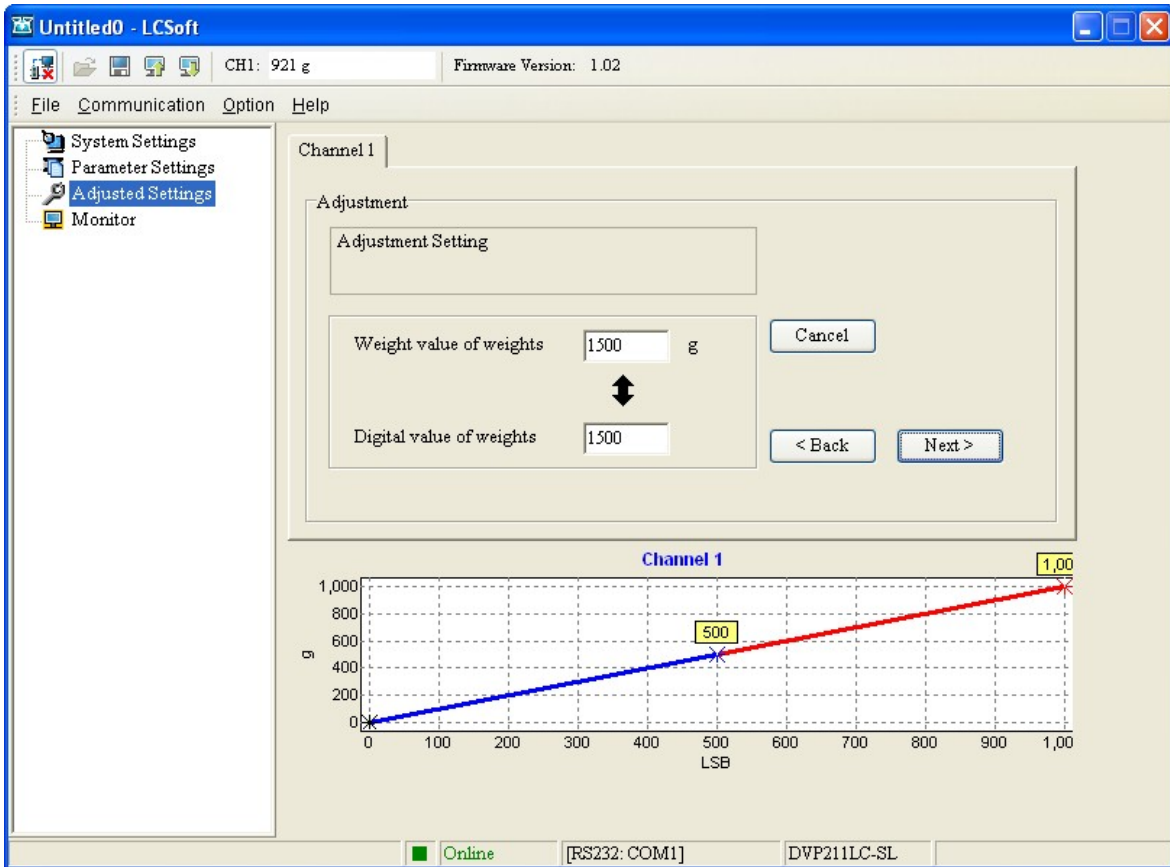

Step 7: The adjustment made is complete, and a curve is displayed. Please see the figures below.

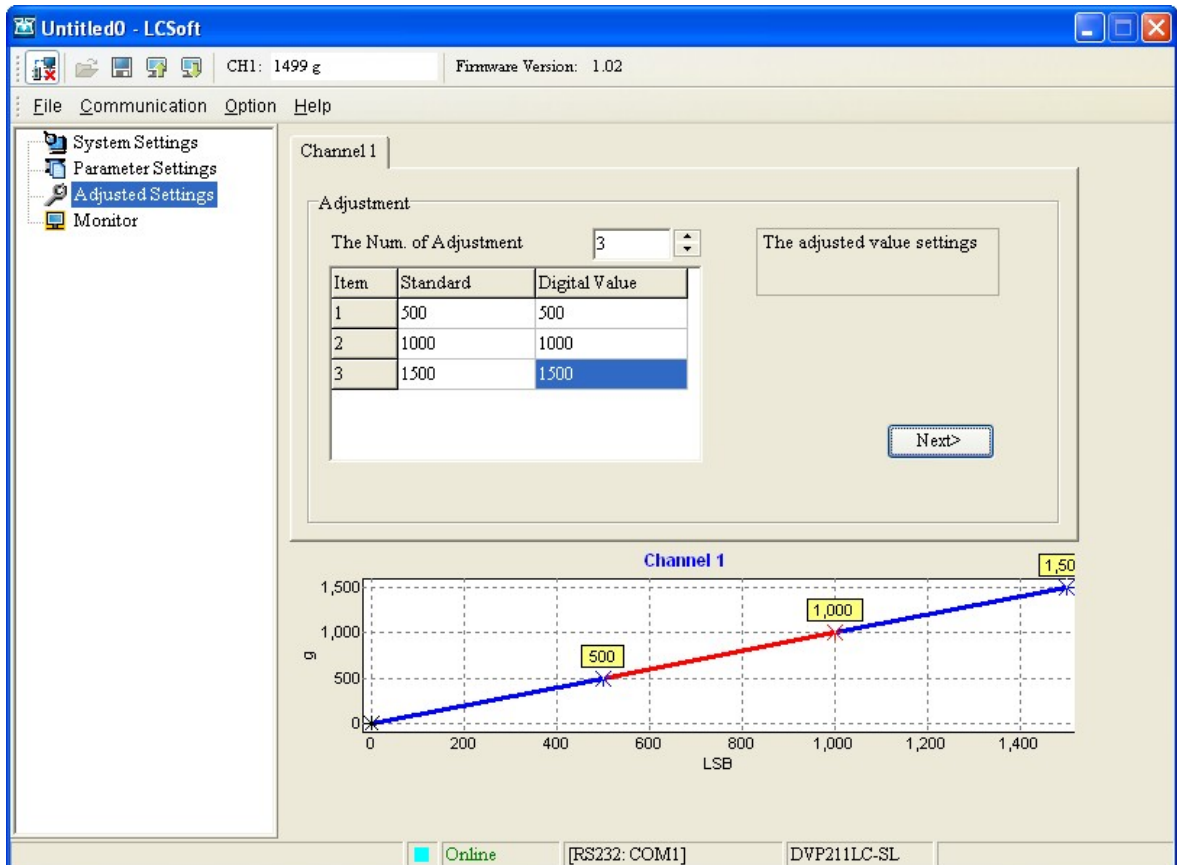

The screenshot shows the main LCSoft interface. The title bar reads "Untitled0 - LCSoft". The status bar at the top shows "CH1: 1499 g" and "Firmware Version: 1.02". The menu bar includes "File", "Communication", "Option", and "Help". The left sidebar has "System Settings", "Parameter Settings", "Adjusted Settings" (highlighted), and "Monitor".

The "Adjusted Settings" window is open, showing "Channel 1" and "Adjustment". The "The Num. of Adjustment" is set to 3. A table displays the adjusted values:

Item	Standard	Digital Value
1	500	500
2	1000	1000
3	1500	1500

Below the table is a "Next>" button. To the right of the table is a box labeled "The adjusted value settings".

Below the adjustment window is a graph titled "Channel 1". The y-axis is labeled "g" and ranges from 0 to 1,500. The x-axis is labeled "LSB" and ranges from 0 to 1,400. A blue line represents the calibration curve, passing through points (0,0), (500,500), (1000,1000), and (1500,1500). The points are marked with 'x' and labeled with their respective values.

At the bottom of the interface, there is a status bar with "Online" (indicated by a green square), "[RS232: COM1]", and "DVP211LC-SL".

5



**MEMO**

5