



Automation for a Changing World

# Delta Heavy Duty Field Oriented Control Drive *CH2000 Series*



[www.deltaww.com](http://www.deltaww.com)

 **DELTA**  
Smarter. Greener. Together.



# CH2000 Power in Hand

With years of experience and expertise in drive technology, Delta presents our new AC motor drive, the CH2000 series. Providing high performance with robust design, the CH2000 is equipped with larger starting torque and high overload capabilities to fulfill the needs of heavy load applications and to deal with sudden load impact conditions.

The CH2000 series is designed with high tolerance for critical environments, especially for heavy load applications. Featuring outstanding controls for all fields and system performance improvements, the CH2000 series offers exceptional quality and comprehensive services.

Introducing the CH2000 series heavy load field-oriented vector control drive to enhance your competitive advantage for achieving greater success.

## Table of Contents

### Functions and Applications

3

- Standard Models
- Excellent Drive Control
- Excellent Overload Capability
- Fast Response to Load Impact
- Large Starting Torque
- Flexible Torque and Current Limit Settings
- Deceleration Energy Backup(dEB)
- Industrial Applications
- Modular Design
- High-Speed Network
- Intelligent PLC Functions
- Permanent Magnet (PM) Motor Applications
- Excellent Environment Adaptability

### Specifications

12

- Environment for Operation, Storage and Transportation
- Operation Temperature and Protection Level
- Product Specifications
- General Specifications

### Wiring

15

### Dimensions

17

### Option Cards

26

### Ordering Information

31

### Model Name

32

### Global Operations

33

# Standard Models

Power Ranges 230V 0.75~75kW, 460V 0.75~280kW

230V (kW)	0.75	1.5	2.2	3.7	5.5	7.5	11	15	18.5	22	30	37	45	55	75
230V (HP)	1	2	3	5	7.5	10	15	20	25	30	40	50	60	75	100
Output (A)	5	8	11	17	25	33	49	65	75	90	120	146	180	215	255
Frame Size	A				B			C		D			E		F
Brakes	Built-in								Optional						
DC Reactor	None								Built-in						
EMI Filter	Optional														
Enclosure Type	21 (IP20, NEMA1)								00 (IP00, UL Open Type)/21 (IP20, NEMA1)						

460V (kW)	0.75	1.5	2.2	3.7	5.5	7.5	11	15	18.5	22	30	37	45	55	75	90	110	132	160
460V (HP)	1	2	3	5	7.5	10	15	20	25	30	40	50	60	75	100	125	150	175	215
Output (A)	3	4	6	9	12	18	24	32	38	45	60	73	91	110	150	180	220	250	310
Frame Size	A				B			C			D			E		F			
Brake	Built-in								Optional										
DC Reactor	None								Built-in										
EMI Filter	Built-in (CH4EA Models)								Optional										
Enclosure Type	21 (IP20, NEMA1)								00 (IP00, UL Open Type)/21 (IP20, NEMA1)										

## Excellent Drive Control

### High Performance

1. Large starting torque
2. High overload capability
3. Super heavy duty setting
4. Fast response to load impact
5. A drive for both induction motors and synchronous motors

### Flexible Applications

1. Control modes for speed, torque, position and synchronous control
2. Built-in PLC functions
3. Excellent 4-quadrant torque control and limit
4. Noise reduction operation



\*Note: Please refer to product specifications below for more detail



185	220	280
250	300	375
370	440	550
G		H
A1)		



## Modular Design

1. Hot plug LCD keypad
2. I/O extension card options
3. PG card options
4. Network cards for fieldbus modules
5. Removable fan

## Adaptability to Critical Environments

1. 50°C operating temperature
2. Built-in DC reactor
3. Coated circuit boards
4. Built-in EMI filter\*
5. Global safety standards (CE/UL/cUL)



# Excellent Overload Capability

The super heavy duty setting is suitable for harsh environment applications with its excellent overload capability. The current overload capability is 150% for 60 seconds and 200% for 3 seconds.

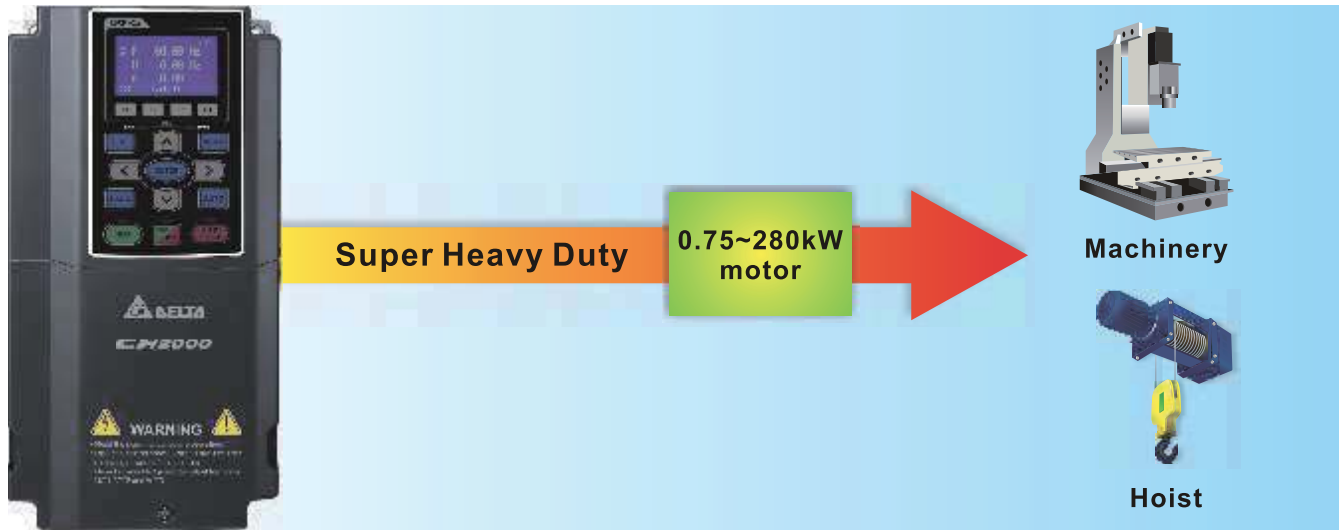

# Fast Response to Load Impact

Response to sudden load impact

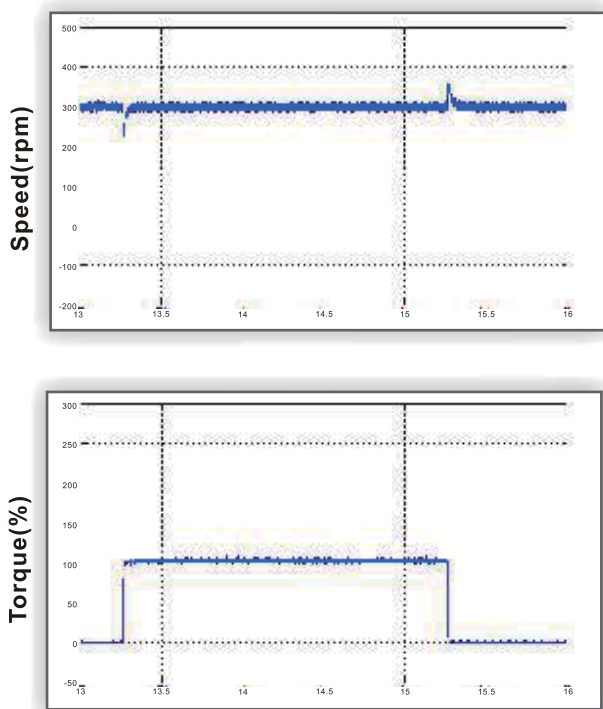

# Large Starting Torque

In FOC+PG mode, the CH2000 is capable of creating a start-up torque up to 200% at extremely low speed for much more stable speed control.

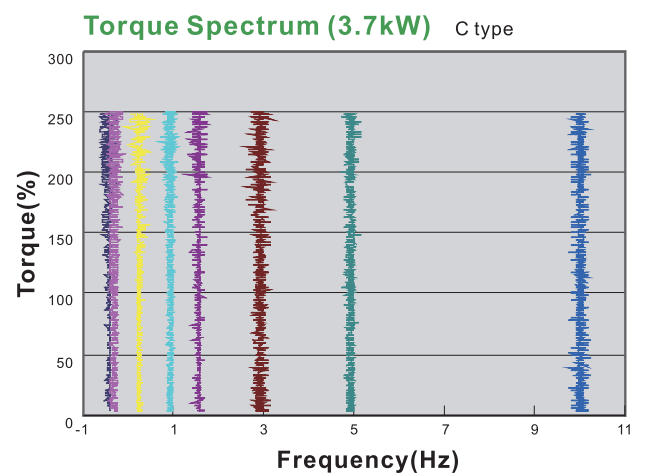
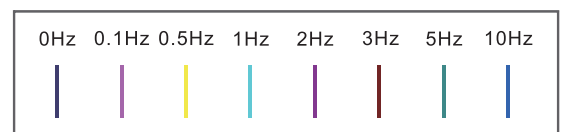



# Flexible Torque and Current Limit Settings

Protects the equipment from damage due to load impact. Under FOC control mode, setting the torque limit can protect the machinery in many aspects. The torque and current limit settings provide the user with a more flexible application.

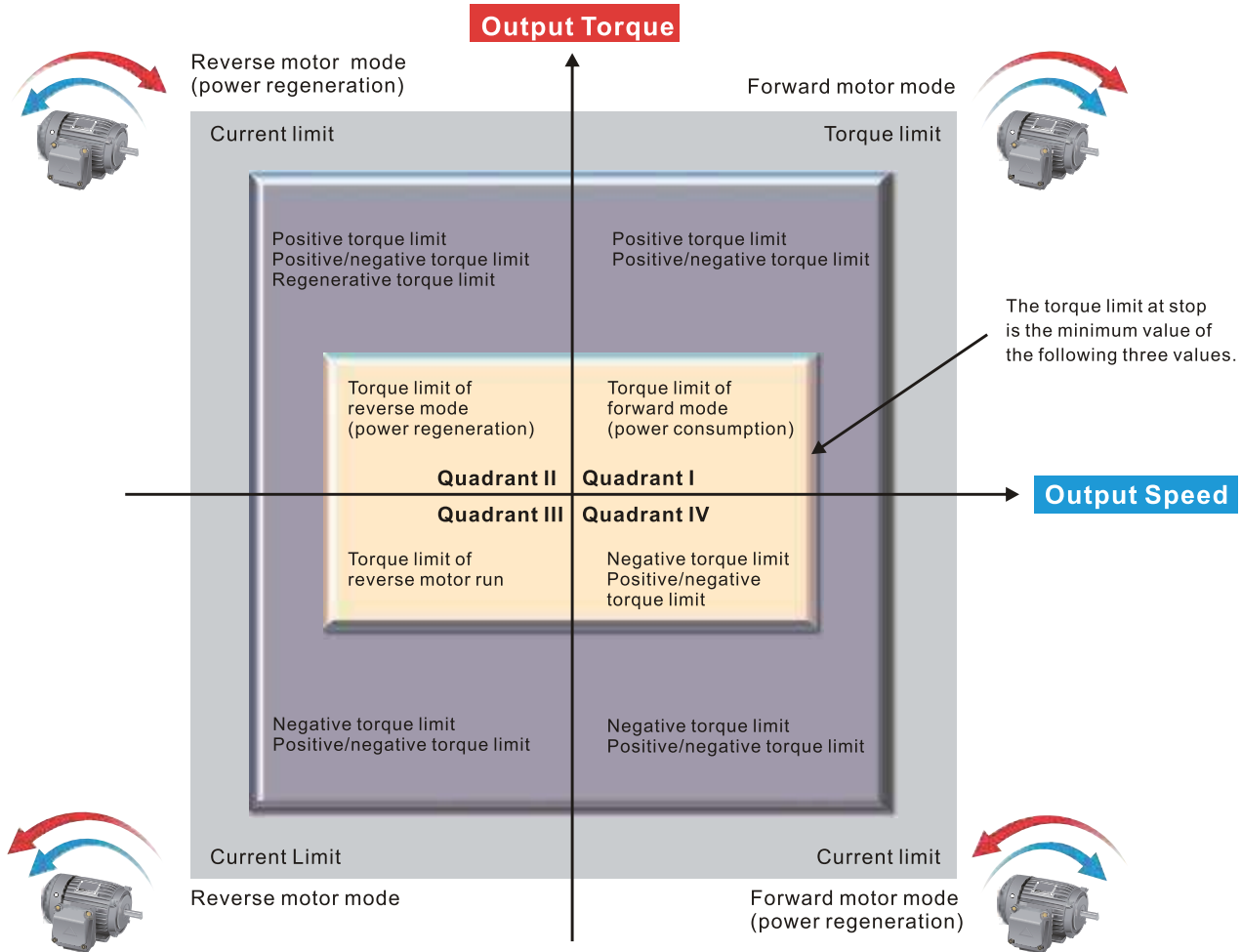

# Deceleration Energy Backup (dEB)

This function controls the motor's deceleration to a stop when sudden power failure occurs to prevent mechanical damage. It then returns the motor to its previous speed when power comes back on.

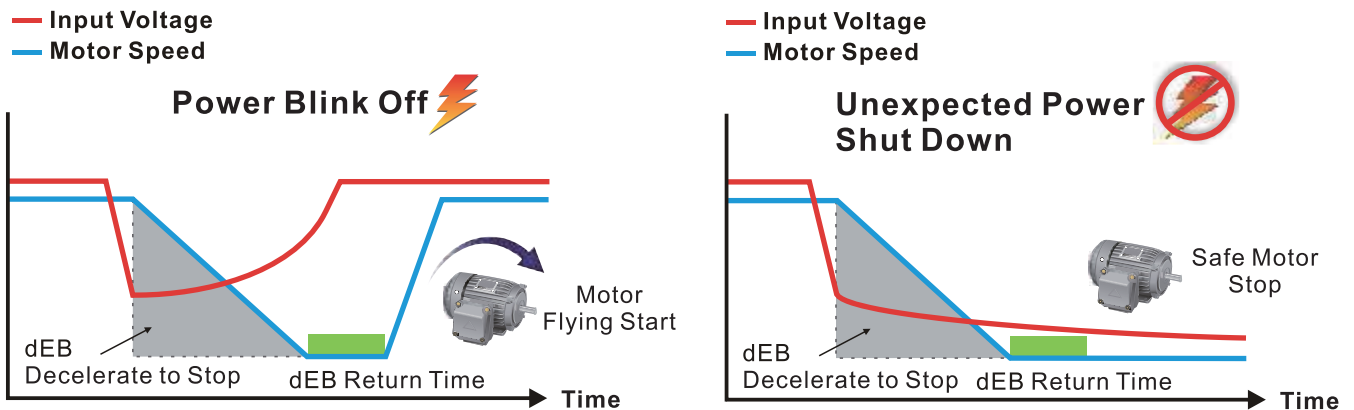

# Industrial Applications

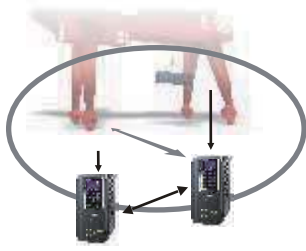

**Speed Synchronizing**

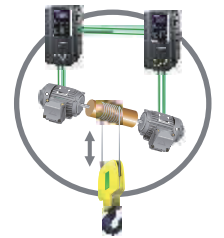
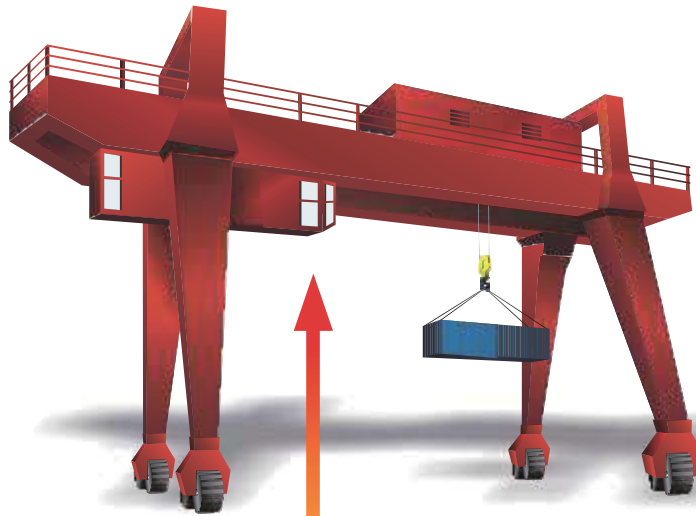

**Load Sharing**

## Delta REG2000 Series Energy Regeneration Application

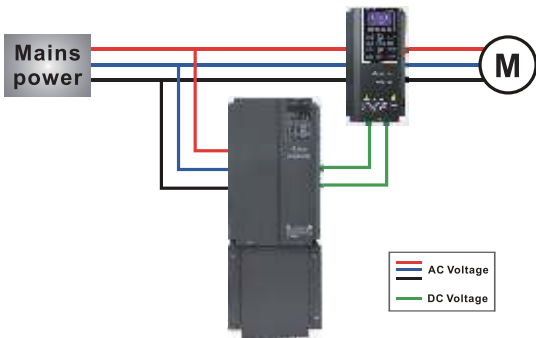

Using the REG2000 with the CH2000 in a crane and hoist application provides the user with a four-quadrant operation and energy saving results.

## CNC Application (C-axis)



The CH2000 provides position control and pulse wave velocity following functions for C-axis applications with high overload capability providing excellent performance for high-speed rigid tapping.

## Delta AFE2000 Series Active Front End Application



The Active Front End Unit (AFE2000) helps to reduce torque ripple and harmonics with higher power factor to provide excellent production quality with energy saving results.



## Advanced crane function

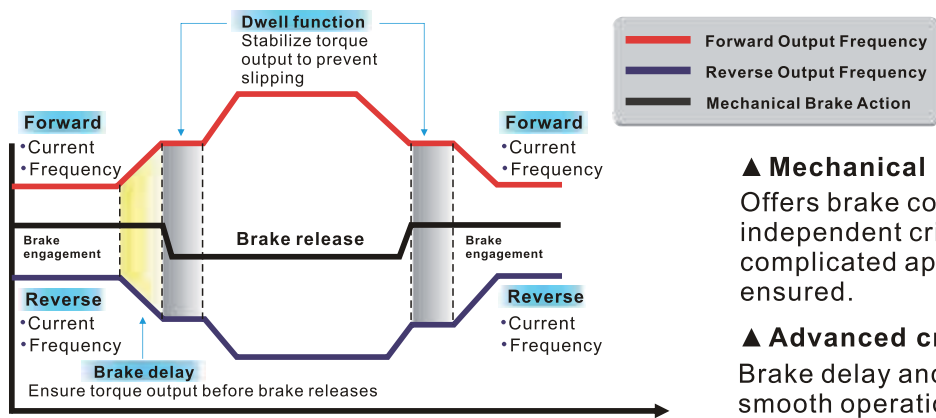

### ▲ Mechanical brake control

Offers brake control setting for 8 independent criteria. Suitable for complicated applications and safety ensured.

### ▲ Advanced crane time sequence

Brake delay and dwell function ensure smooth operation.

## Fast Response to Load Impact

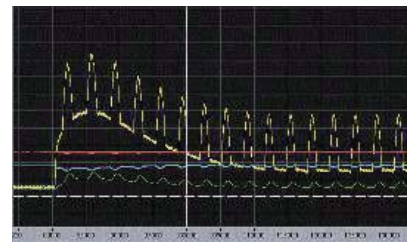
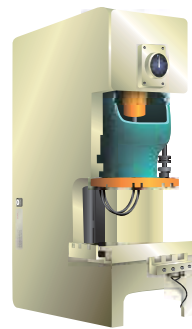

High endurance. Maintains a stable DC Bus voltage when load impact occurs.

## Tension Control



## Torque Ripple

Other Delta Products

CH2000

CH2000+AFE



# Modular Design

The modular design fulfills the needs of system applications and facilitates equipment maintenance. Various accessory options are available such as: I/O extension cards, encoder feedback cards, communication cards, a hot plug LCD keypad, removable terminals and a removable fan.

**PG Feedback Cards**

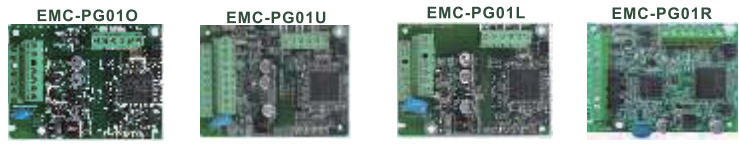

**I/O Cards**



**Communication Cards**

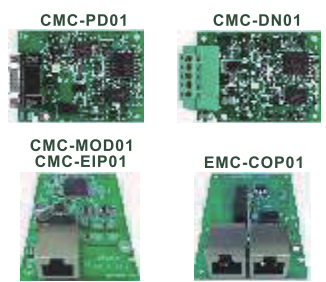

- KPC-CC01 keypad
- Push On/Off design, easy removal
- Supports standard RJ45 extension cable for distance operation

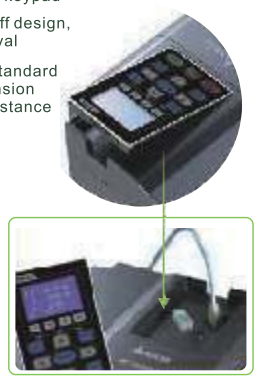

- RFI Switch



- Loosen the safety screw on the top cover, press left and right sides to remove the cover, then start wiring



- Modular fan design facilitates replacement and cleaning for a longer product life



- Product nameplate shows the input/output voltage, input/output current, the frequency range and more



**Removable terminals**

Convenient wiring and safety equipment

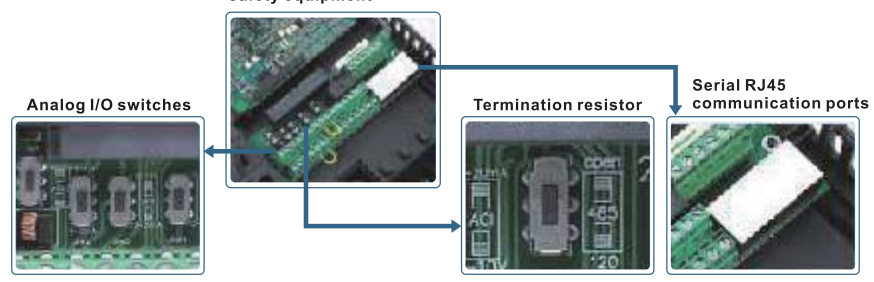



# High-speed Network

- Provides optional MODBUS RTU and various fieldbus cards for flexible communication applications
- Advanced network functions
- Built-in MODBUS communication interface
- **CANopen (DS402)** EMC-COP01 is optional for all series



## Ability to control up to 8 Slave drives via the CANopen Master function

- Supports all Delta industrial automation products (all EDS files of Delta industrial automation products are built-in)
- I/O data layout of each piece of equipment on the CANopen Network
- Planning function for motion control
- WPL Soft

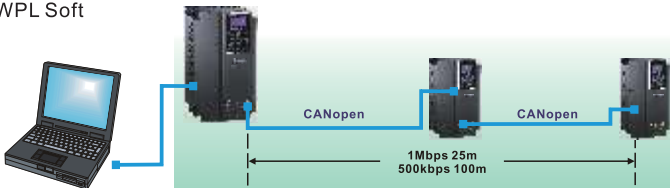

- TAP-CN03 distribution box for long distances



- Cable cable



Delta DeviceNet Builder software is specially designed for DeviceNet communication. With this software, it is easy to plan DeviceNet equipment and remote I/O via parameters to build a standard DeviceNet monitoring structure.

- Supports all Delta industrial automation products (all EDS files of Delta industrial automation products are built-in)
- I/O data layout of each piece of equipment in the DeviceNet network
- DeviceNet layout software



## MODBUS TCP

Delta's communication integrator software not only provides graphic module settings and human interface design but also supports settings and online monitoring for all Ethernet products

- Delta software for Ethernet/MODBUS TCP products
- Graphic module settings and human interface design
- Auto search function
- Setting interface for virtual COM port



# Intelligent PLC Functions

- Built-in 10K steps capacity of PLC functions. Distributed control and independent operation are easily achieved via network connection
- CANopen Master protocol and PLC functions provide synchronous control and fast data exchange

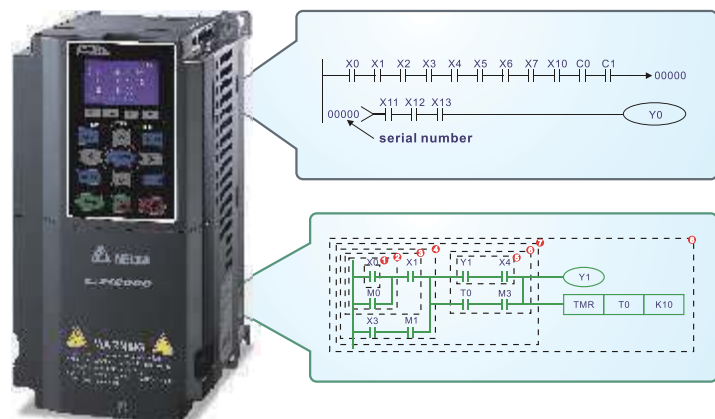

# Permanent Magnet (PM) Motor Application

The CH2000 series is capable of driving both induction motors and permanent magnet (PM) motors. Using a PM motor provides benefits including dynamic response and precise position control, speed control and torque control.

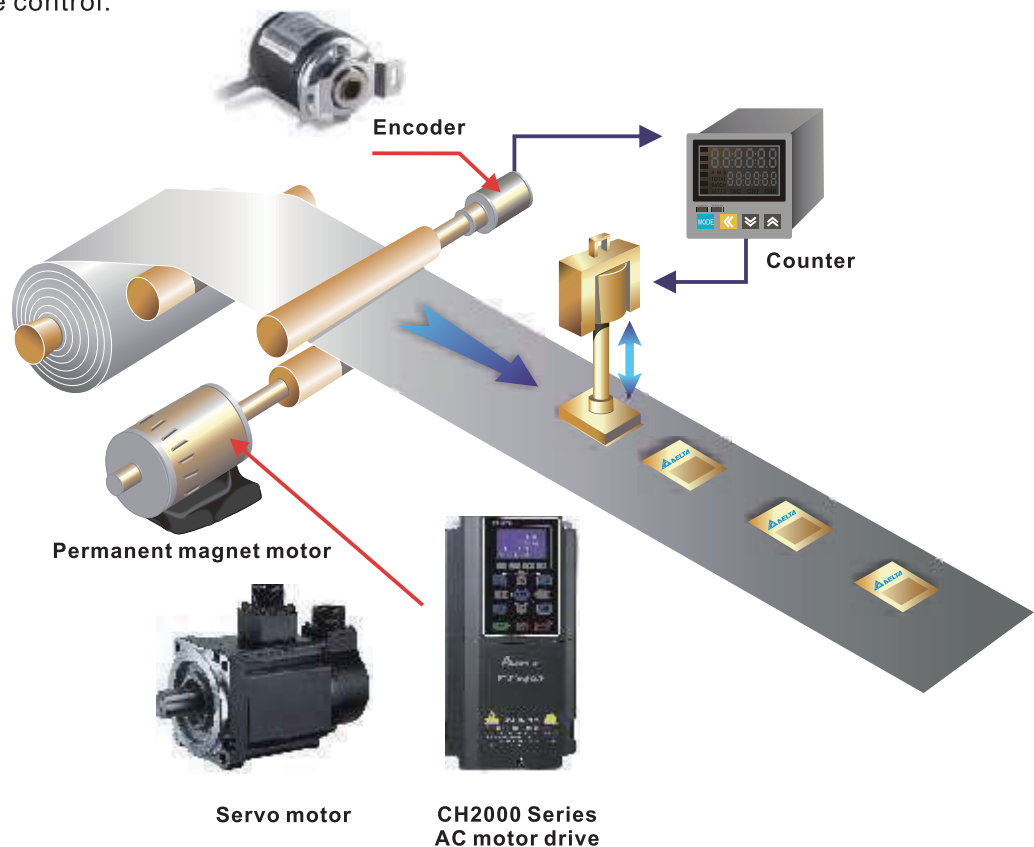

## Excellent Environment Adaptability

- Built-in DC choke\*
- Built-in EMI filter\*
- Enhanced PCB control board coating for safe operation in harsh environment applications
- Isolation design of heat dissipation system separate from other drive components
- There are two heat dissipating methods:
  - (1) A flange mounting helps disperse heat out of the drive
  - (2) A cooling fan provides cold air to the aluminum heat sink. These two methods are both efficient and can be selected according to working environment conditions for the best heat dissipation results



\*Note. Please refer to the product specifications in the following pages.



# Environment for Operation, Storage and Transportation

DO NOT expose the AC motor drive to environments that have dust, direct sunlight, corrosive / inflammable gases, humidity, liquid or vibrations. The salt in the air must be less than 0.01mg/cm<sup>2</sup> year.

Environment	Installation location	IEC60364-1/IEC60664-1 Pollution degree 2 , Indoor use only	
	Surrounding Temperature	Storage / Transportation	-25°C ~ +70°C
		Non-condensation, non-frozen	
	Rated Humidity	Operation	Max. 90%
		Storage / Transportation	Max. 95%
		No condense water	
	Air Pressure	Operation / Storage	86 to 106 kPa
		Transportation	70 to 106 kPa
	Pollution Level	IEC721-3-3	
		Operation	Class 3C2 : Class 3S2
Storage		Class 2C2 : Class 2S2	
Transportation		Class 1C2 : Class 1S2	
Altitude	Operation	If the AC motor drive is installed at an altitude of 0~1000m, follow normal operating restrictions. If it is installed at an altitude of 1000~3000m, decrease 2% of rated current or lower 0.5°C of temperature for every 100m increase in altitude. Maximum altitude for Corner Grounded is 2000m.	
Package Drop	Storage / Transportation	ISTA procedure 1A(according to weight) IEC60068-2-31	
Vibration	1.0mm, peak to peak value range from 2Hz to 13.2 Hz; 0.7G~1.0G range from 13.2Hz to 55Hz; 1.0G range from 55Hz to 512 Hz. Comply with IEC 60068-2-6		
Impact	IEC/EN 60068-2-27		
Operation Position	Max. allowed offset angle 10° (under normal installation position)		

## Operation Temperature and Protection Level

Model	Frame	Top Cover	Conduit Box	Protection Level	Operation Temperature
VFDxxxxCH23A-21 VFDxxxxCH43A-21	Frame A~C 230V: 0.75~18.5kW 460V: 0.75~30kW	Top cover Removed	Standard conduit plate	IP20/UL Open Type	SHD: -10°C ~50°C
		Standard with top cover		IP20/UL Type1/NEMA1	
VFDxxxxCH4EA-21 VFDxxxxCH43C-21	Frame D~H 230V: 22kW and above 460V: 37kW and above	N/A	Standard conduit box	IP20/UL Type1/NEMA1	SHD: -10°C ~40°C
VFDxxxxCH23A-00 VFDxxxxCH43A-00 VFDxxxxCH43C-00	Frame D~H 230V: 22kW and above 460V: 37kW and above	N/A	Without standard conduit box	IP00 IP20/UL Open Type  Only the circled area is Ip00, other are Ip20.	SHD: -10°C ~50°C

# Product Specifications



230V		A				B			C			D			E		F
Frame Size		007	015	022	037	055	075	110	150	185	220	300	370	450	550	750	
Model VFD-□□□CH23A-21		007	015	022	037	055	075	110	150	185	220	300	370	450	550	750	
Applicable Motor Output (kW)		0.75	1.5	2.2	3.7	5.5	7.5	11	15	18.5	22	30	37	45	55	75	
Applicable Motor Output (hp)		1	2	3	5	7.5	10	15	20	25	30	40	50	60	75	100	
Output Rating	Super Heavy DUTY	Rate Output Capacity (kVA)	2.0	3.2	4.4	6.8	10	13	20	26	30	36	48	58	72	86	102
		Rated Output Current (A)	5	8	11	17	25	33	49	65	75	90	105	146	180	215	276
		Carrier Frequency (kHz)	5~15kHz														
		Overload Tolerance	Rated output current is 150% for 60 seconds Rated output current is 200% for 3 seconds														
Input Rating	Input Current (A) Super Heavy Duty		6.4	12	16	20	28	36	52	72	83	99	124	143	171	206	245
	Rated Voltage/Frequency		3-phase AC 200V~240V (-15% ~ +10%), 50/60Hz														
	Operating Voltage Range		170~265Vac														
	Frequency Tolerance		47~63Hz														
AC Drive Weight		2.6±0.3Kg			5.4±1Kg			9.8±1.5Kg			38.5±1.5Kg			64.8±1.5Kg		86.5±1.5Kg	
Cooling method		Natural cooling	Fan cooling														
Braking Chopper		Frame A to C (built-in); Frame D and above (optional)															
DC reactor		Frame A to C (optional); Frame D and above (built-in)															
EMI Filter		Optional															
EMC-COP01		Optional															

460V		A				B			C				
Frame Size		007	015	022	037	055	075	110	150	185	220	300	
Model VFD-□□□CH43A-21; VFD-□□□CH4EA-21;		007	015	022	037	055	075	110	150	185	220	300	
Applicable Motor Output (kW)		0.75	1.5	2.2	3.7	5.5	7.5	11	15	18.5	22	30	
Applicable Motor Output (hp)		1	2	3	5	7.5	10	15	20	25	30	40	
Output Rating	Super Heavy DUTY	Rate Output Capacity (kVA)	2.0	3.2	4.8	7.2	9.6	14	19	25	30	36	48
		Rated Output Current (A)	3	4	6	9	12	18	24	32	38	45	60
		Carrier Frequency (kHz)	5~15kHz										
		Overload Tolerance	Rated output current is 150% for 60 seconds Rated output current is 200% for 3 seconds										
Input Rating	Input Current (A) Super Heavy Duty		4.3	5.9	8.7	14	17	20	26	35	40	47	63
	Rated Voltage/Frequency		3-phase AC 380V~480V (-15% ~ +10%), 50/60Hz										
	Operating Voltage Range		323~528Vac										
	Frequency Tolerance		47~63Hz										
AC Drive Weight		2.6±0.3Kg				5.4±1Kg			9.8±1.5Kg				
Cooling Method		Natural cooling	Fan cooling										
Braking Chopper		Frame A to C (built-in); Frame D and above (optional)											
DC Reactor		Frame A to C (optional); Frame D and above (built-in)											
EMI Filter		Frame A ~ C, VFD□□□□CH4EA-21, EMI filter built-in Frame A ~ C, VFD□□□□CH43A-21, No EMI filter											
EMC-COP01		Optional											

460V

Frame Size		D				E		F	G			H		
Model VFD-□□□□CH43A-□□; VFD-2800CH43A-00/21;		370	450	550	750	900	1100	1320	1600	1850	2200	2800		
Applicable Motor Output (kVA)		37	45	55	75	90	110	132	160	185	220	280		
Applicable Motor Output (hp)		50	60	75	100	125	150	175	215	250	300	375		
Output Rating	Super Heavy DUTY	Rate Output Capacity (kW)		58	73	88	120	143	175	199	247	438		
		Rated Output Current (A)		73	91	110	150	180	220	250	310	370	440	550
		Carrier Frequency (kHz)		5~15kHz										
		Overload Tolerance		Rated output current is 150% for 60 seconds Rated output current is 200% for 3 seconds										
Input Rating	Input Current (A) Super Heavy Duty		74	101	114	157	167	207	240	300	380	400	494	
	Rated Voltage/Frequency		3相 AC 380V~480V (-15% ~ +10%), 50/60Hz											
	Operating Voltage Range		323~528Vac											
	Frequency Tolerance		47~63Hz											
AC Drive Weight		38.5± 1.5Kg				64.8± 1.5Kg		86.5± 1.5Kg	134± 4Kg			228Kg		
Cooling Method		Fan cooling												
Braking Chopper		Frame D and above (optional)												
DC Reactor		Frame D and above (built-in)												
EMI Filter		Optional												
EMC-COP01		Optional												

## General Specifications

Control Characteristics	Control Method	1: V/F, 2: SVC, 3: VF+PG, 4: FOC+PG, 5: TQC+PG,
	Starting Torque	Reach up to 200% or above at 0.5Hz. Under FOC+PG mode, starting torque can reach 200% at 0Hz.
	V/F Curve	4 point adjustable V/F curve and square curve
	Speed Response Ability	5Hz (vector control can reach up to 40Hz)
	Torque Limit	Max. 220% torque current
	Torque Accuracy	±5%
	Max. Output Frequency (Hz)	Super Heavy Duty: 0.00~600.00Hz
	Frequency Output Accuracy	Digital command: 0.01%, -10°C~+40°C, Analog command: 0.1%, 25±10°C
	Output Frequency Resolution	Digital command: 0.01Hz, Analog command: 0.03 X max. output frequency/60 Hz (±11 bit)
	Overload Tolerance	Rated output current is 150 % for 60 seconds Rated output current is 200% for 3 seconds
Frequency Setting Signal	+10V~-10 · 0~+10V · 4~20mA · 0~20mA · Pulse input	
Accel./decel. Time	0.00~600.00/0.0~6000.0 seconds	
Main Control Function	Torque control, Droop control, Speed/torque control switching, Feed forward control, Zero-servo control, Momentary power loss ride thru, Speed search, Over-torque detection, Torque limit, 17-step speed (max), Accel/decel time switch, S-curve accel/decel, 3-wire sequence, Auto-Tuning (rotational, stationary), Dwell, Cooling fan on/off switch, Slip compensation, Torque compensation, JOG frequency, Frequency upper/lower limit settings, DC injection braking at start/stop, High slip braking, PID control (with sleep function), Energy saving control, MODBUS communication (RS-485 RJ45, max. 115.2 kbps), Fault restart, Parameter copy	
Fan Control	230V model : VFD150CH23A-21(include) and series above: PMW control VFD110CH23A-21(include) and series below: on/off switch control 460V model : VFD185CH43A/4EA-21(include) and series above: PMW control VFD150CH43A/4EA-21(include) and series below: on/off switch control	
Protection Characteristics	Motor Protection	Electronic thermal relay protection
	Over-current Protection	For drive model 230V and 440V Over-current protection for 300% rated current current clamp 『 Super heavy duty: 220% 』
	Over-voltage Protection	230: drive will stop when DC-BUS voltage exceeds 410V 460: drive will stop when DC-BUS voltage exceeds 820V
	Over-temperature Protection	Built-in temperature sensor
	Stall Prevention	Stall prevention during acceleration, deceleration and running independently
	Restart After Instantaneous Power Failure	Parameter setting up to 20 seconds
	Grounding Leakage Current Protection	Leakage current is higher than 50% of rated current of the AC motor drive
Certifications	  GB/T12668-2  (certification in progress)	



# Wiring

Frame A~C  
Provides 3-phase power

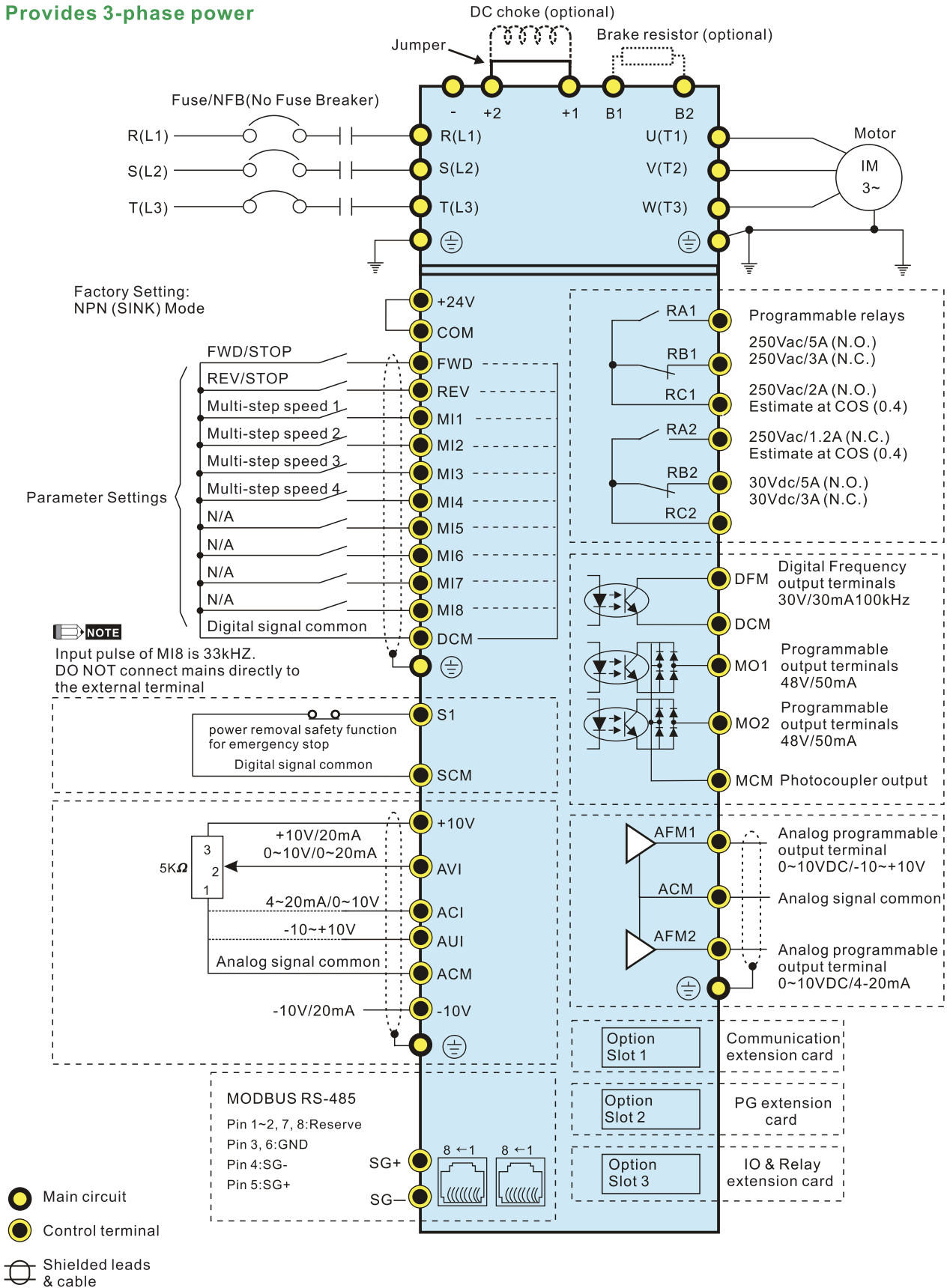

**Frame G and H  
Provides 3-phase power**

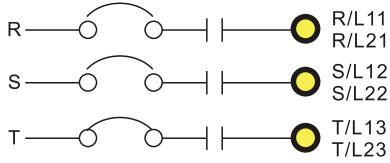

Provides 12-phase power

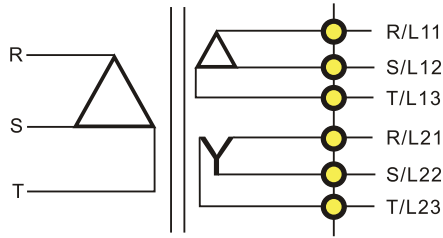

**Frame D and for frames above  
Provides 3-phase power**

Fuse/NFB(No Fuse Breaker)

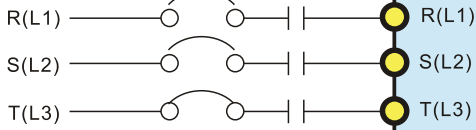

+1/DC+

-/DC-

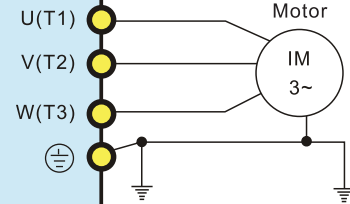

Factory Setting:  
NPN (SINK) Mode

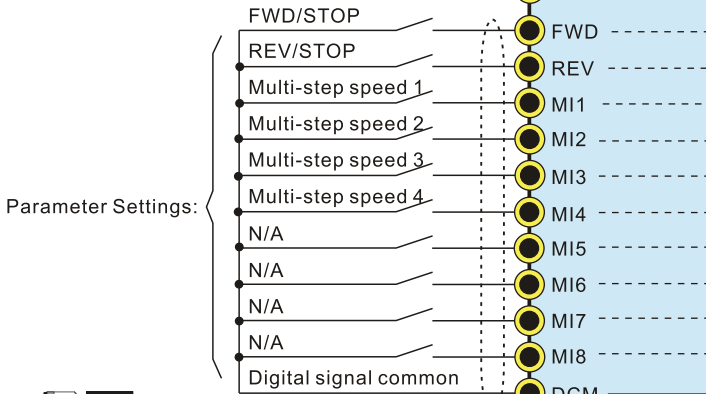

**NOTE**

Input pulse of MI8 is 33kHz.  
DO NOT connect mains directly  
to the external terminal

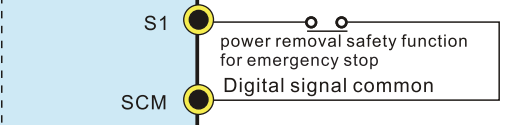
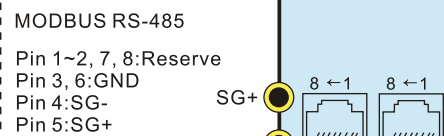
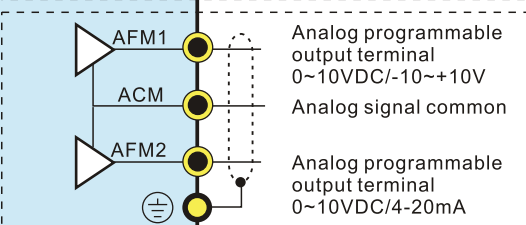
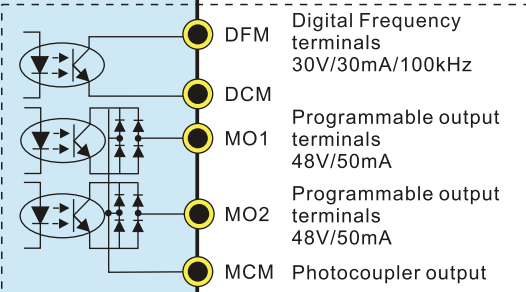
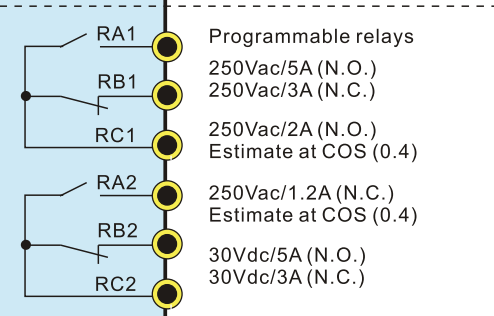
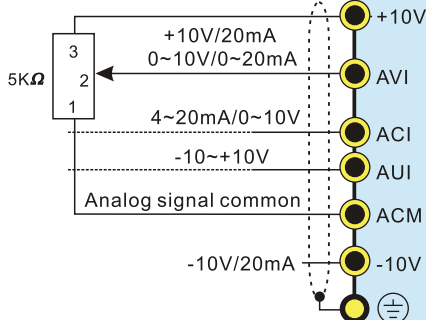

- Main circuit
- Control terminal
- Shielded leads & cable

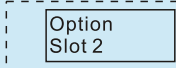
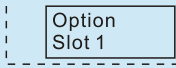
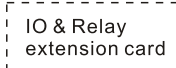

# Dimensions

## Digital Keypad

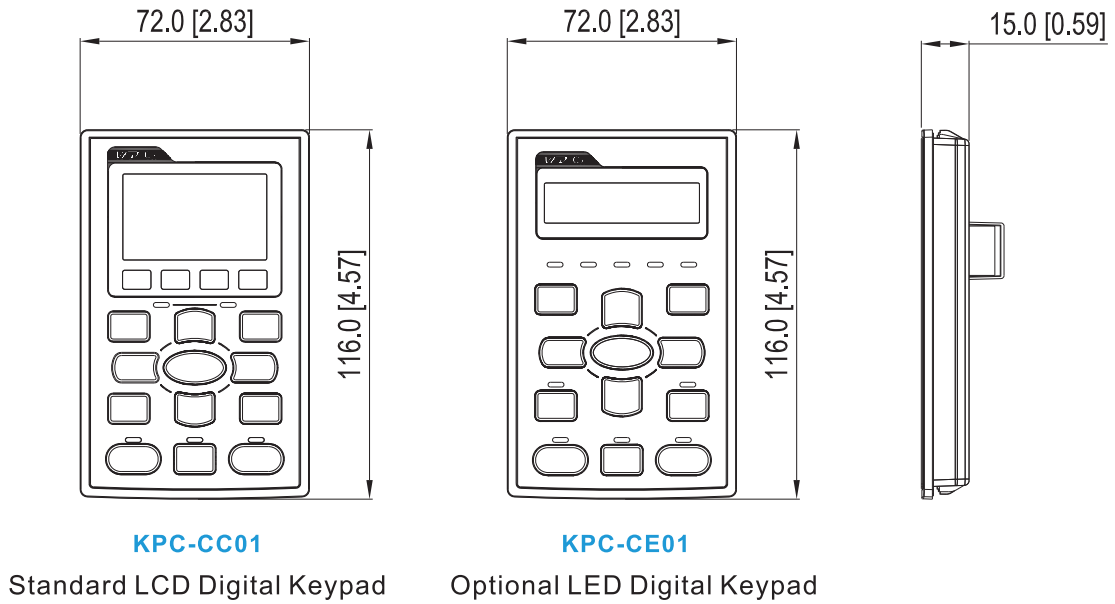

## Frame A

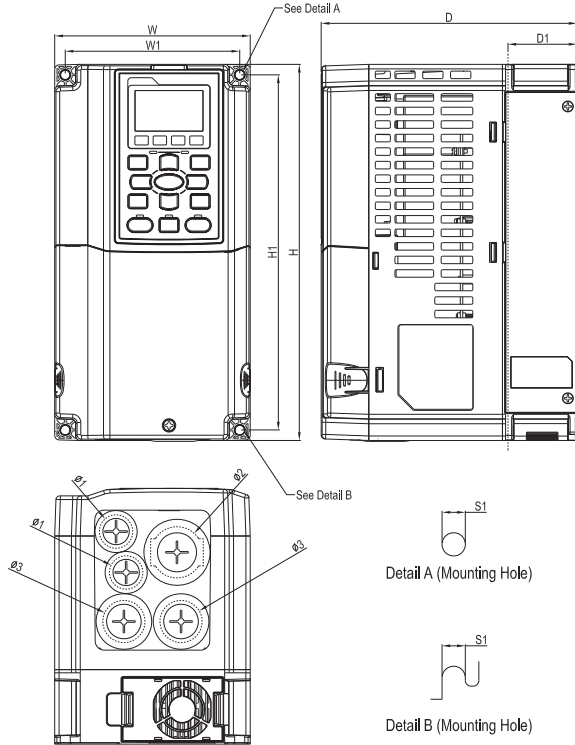

### MODEL

VFD007CH23A-21	VFD055CH43A-21
VFD015CH23A-21	VFD007CH4EA-21
VFD022CH23A-21	VFD015CH4EA-21
VFD037CH23A-21	VFD022CH4EA-21
VFD007CH43A-21	VFD037CH4EA-21
VFD015CH43A-21	VFD055CH4EA-21
VFD022CH43A-21	
VFD037CH43A-21	

Unit : mm[inch]

Frame	W	H	D	W1	H1	D1*	S1	Ø1	Ø2	Ø3	
A	mm	130.0	250.0	170.0	116.0	236.0	45.8	6.2	22.2	34.0	28.0
	inch	[5.12]	[9.84]	[6.69]	[4.57]	[9.29]	[1.80]	[0.24]	[0.87]	[1.34]	[1.10]



■ **Frame B**

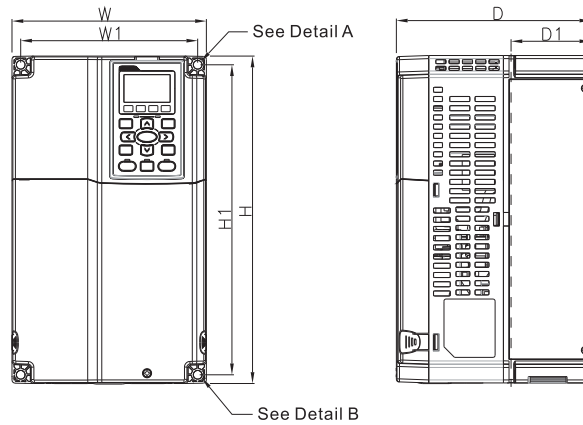

**MODEL**

- VFD055CH23A-21
- VFD075CH23A-21
- VFD110CH23A-21
- VFD075CH43A-21
- VFD110CH43A-21
- VFD150CH43A-21
- VFD075CH4EA-21
- VFD110CH4EA-21
- VFD150CH4EA-21

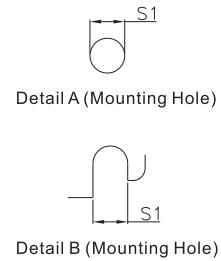
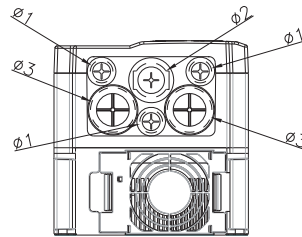

Unit : mm[inch]

Frame		W	H	D	W1	H1	D1*	S1	Ø1	Ø2	Ø3
B	mm	190.0	320.0	190.0	173.0	303.0	77.9	8.5	22.2	34.0	28.0
	inch	7.48	12.60	7.48	6.81	11.93	3.07	0.33	0.87	1.34	1.10

D\*1: Flange Mounting

■ **Frame C**

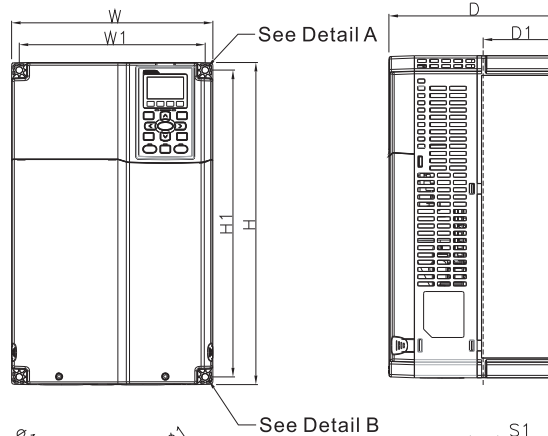

**MODEL**

- VFD150CH23A-21
- VFD185CH23A-21
- VFD185CH43A-21
- VFD220CH43A-21
- VFD300CH43A-21
- VFD185CH4EA-21
- VFD220CH4EA-21
- VFD300CH4EA-21

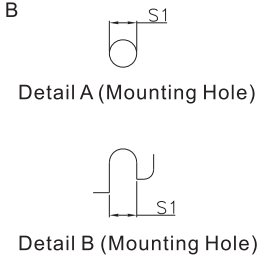
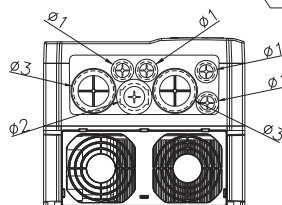

Unit : mm[inch]

Frame		W	H	D	W1	H1	D1*	S1	Ø1	Ø2	Ø3
C	mm	250.0	400.0	210.0	231.0	381.0	92.9	8.5	22.2	34.0	50.0
	inch	9.84	15.75	8.27	9.09	15.00	3.66	0.33	0.87	1.34	1.97

D\*1: Flange Mounting

# Dimensions

## ■ Frame D1

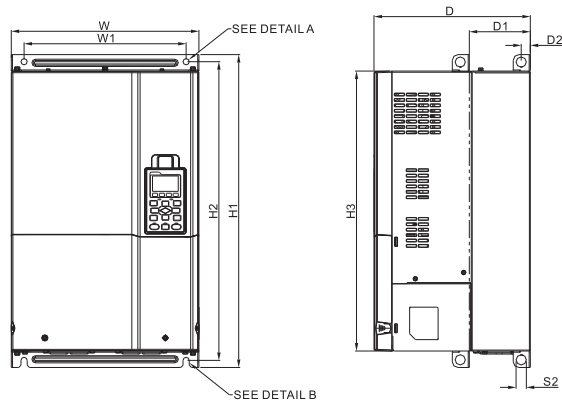

## MODEL

- VFD220CH23A-00
- VFD370CH23A-00
- VFD450CH43A-00
- VFD550CH43A-00
- VFD750CH43A-00

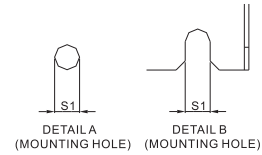
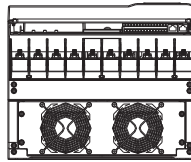

Unit : mm[inch]

Frame	W	H	D	W1	H1	H2	H3	D1*	D2	S1	S2	Ø1	Ø2	Ø3	
D1	mm inch	330.0 [12.99]	-	275.0 [10.83]	285.0 [11.22]	550.0 [21.65]	525.0 [20.67]	492.0 [19.37]	107.2 [4.22]	16.0 [0.63]	11.0 [0.43]	18.0 [0.71]	-	-	-

## ■ Frame D2 Frame D0-2

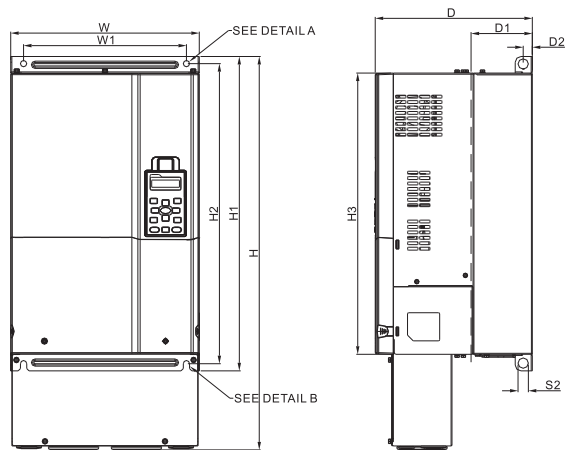

## MODEL

- VFD220CH23A-21
- VFD300CH23A-21
- VFD370CH23A-21
- VFD370CH43S-21
- VFD450CH43A-21
- VFD550CH43A-21
- VFD750CH43A-21

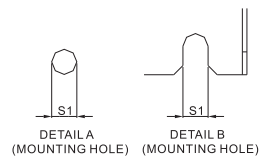
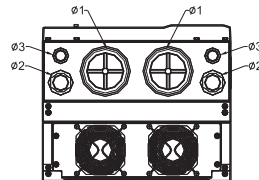

Frame	W	H	D	W1	H1	H2	H3	D1*	D2	S1	S2	Ø1	Ø2	Ø3	
D2	mm inch	330.0 [12.99]	688.3 [27.10]	275.0 [10.83]	285.0 [11.22]	550.0 [21.65]	525.0 [20.67]	492.0 [19.37]	107.2 [4.22]	16.0 [0.63]	11.0 [0.43]	18.0 [0.71]	76.2 [3.00]	34.0 [1.34]	22.0 [0.87]
D0-2	mm inch	280.0 [11.02]	614.4 [24.19]	255.0 [10.04]	235.0 [9.25]	500.0 [19.69]	475.0 [18.70]	442.0 [17.40]	94.2 [3.71]	16.0 [0.63]	11.0 [0.43]	18.0 [0.71]	62.7 [2.47]	34.0 [1.34]	22.0 [0.87]

■ Frame E1

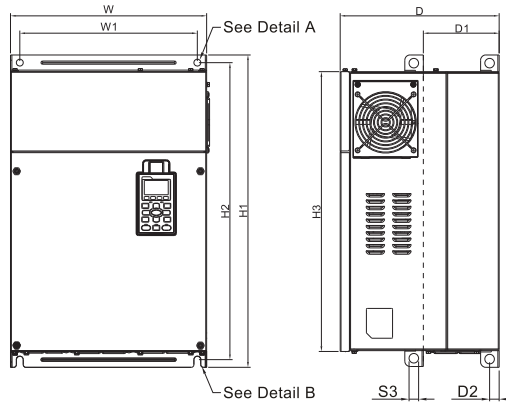

MODEL

- VFD450CH23A-00
- VFD550CH23A-00
- VFD900CH43A-00
- VFD1100CH43A-00

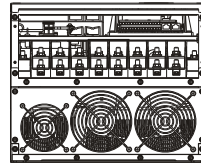

Unit : mm[inch]

Frame		W	H	D	W1	H1	H2	H3	D1*	D2	S1,S2	S3	Ø1	Ø2	Ø3
E1	mm	370.0	-	300.0	335.0	589	560.0	528.0	143.0	18.0	13.0	18.0	-	-	-
	inch	[14.57]	-	[11.81]	[13.19]	[23.19]	[22.05]	[20.80]	[5.63]	[0.71]	[0.51]	[0.71]	-	-	-

■ Frame E2

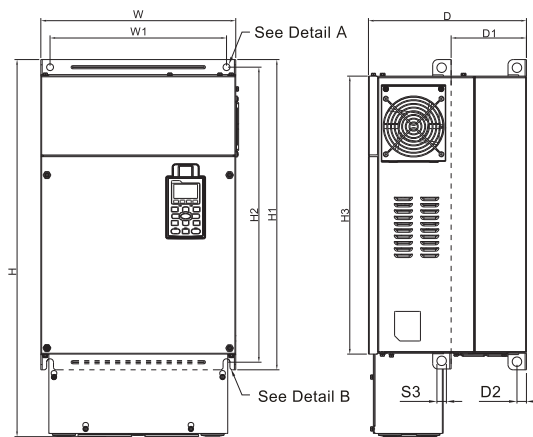

MODEL

- VFD450CH23A-21
- VFD550CH23A-21
- VFD750CH23A-21
- VFD900CH43A-21
- VFD1100CH43A-21

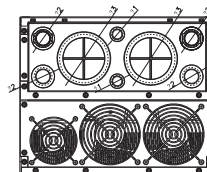

Unit : mm[inch]

Frame		W	H	D	W1	H1	H2	H3	D1*	D2	S1,S2	S3	Ø1	Ø2	Ø3
E2	mm	370.0	715.8	300.0	335.0	589	560.0	528.0	143.0	18.0	13.0	18.0	22.0	34.0	92.0
	inch	[14.57]	[28.18]	[11.81]	[13.19]	[23.19]	[22.05]	[20.80]	[5.63]	[0.71]	[0.51]	[0.71]	[0.87]	[1.34]	[3.62]



# Dimensions

## ■ Frame F1

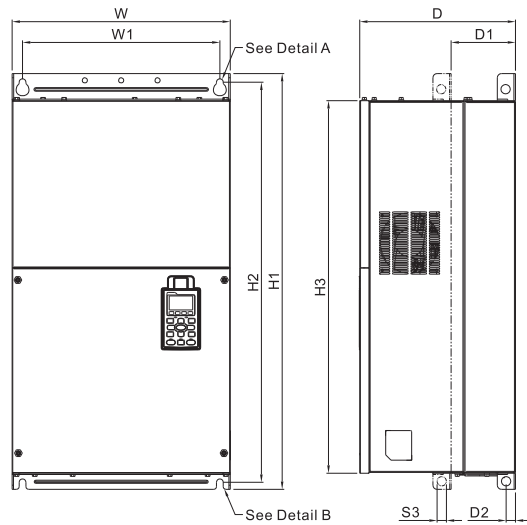

## MODEL

VFD750CH23A-00  
VFD1320CH43A-00

Unit : mm[inch]

Frame	W	H	D	W1	
F1	mm inch	420.0 [16.54]	-	300.0 [11.81]	380.0 [14.96]

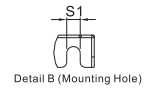
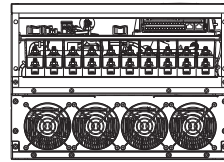

Frame	H1	H2	H3	D1*	D2	S1	S2	S3	Ø1	Ø2	Ø3	
F1	mm inch	800.0 [31.50]	770.0 [30.32]	717.0 [28.23]	124.0 [4.88]	18.0 [0.71]	13.0 [0.51]	25.0 [0.98]	18.0 [0.71]	-	-	-

D1\* : Flange Mounting

## ■ Frame F2

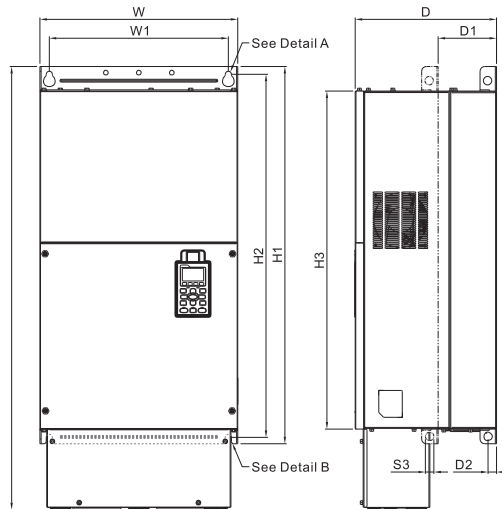

## MODEL

VFD750CH23A-21  
VFD1320CH43A-21

Unit : mm[inch]

Frame	W	H	D	W1	
F2	mm inch	420.0 [16.54]	940.0 [37.00]	300.0 [11.81]	380.0 [14.96]

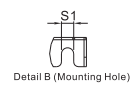
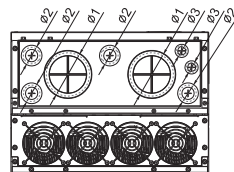

Frame	H1	H2	H3	D1*	D2	S1	S2	S3	Ø1	Ø2	Ø3	
F2	mm inch	800.0 [31.50]	770.0 [30.32]	717.0 [28.23]	124.0 [4.88]	18.0 [0.71]	13.0 [0.51]	25.0 [0.98]	18.0 [0.71]	92.0 [3.62]	35.0 [1.38]	22.0 [0.87]

D1\* : Flange Mounting

## ■ Frame G1

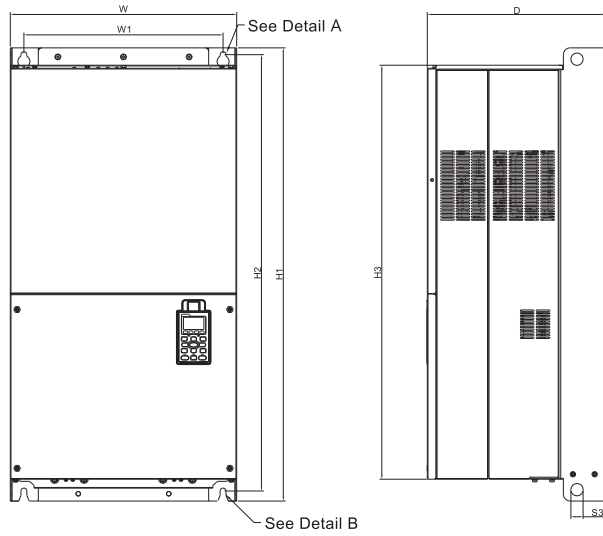

### MODEL

VFD1600CH43A-00  
 VFD1850CH43A-00  
 VFD2200CH43A-00

Unit : mm[inch]

Frame	W	H	D
G1	mm inch	500.0 [19.69]	- [15.63]

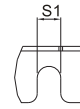
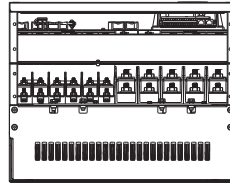

Detail a(MountingHole) Detail B(MountingHole)

Frame	W1	H1	H2	H3	S1	S2	S3	Ø1	Ø2	Ø3	
G1	mm inch	440.0 [217.32]	1000.0 [39.37]	963.0 [37.91]	913.6 [35.97]	13.0 [0.51]	26.5 [1.04]	27.0 [1.06]	-	-	-

## ■ Frame G2

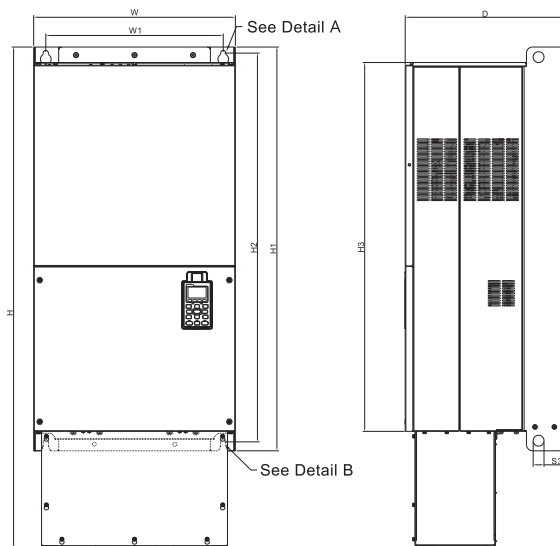

### MODEL

VFD1600CH43A-21  
 VFD1850CH43A-21  
 VFD2200CH43A-21

Unit : mm[inch]

Frame	W	H	D
G2	mm inch	500.0 [19.69]	1240.2 [48.83]

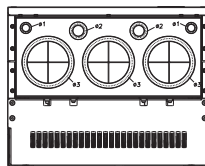

Detail a(MountingHole) Detail B(MountingHole)

Frame	W1	H1	H2	H3	S1	S2	S3	Ø1	Ø2	Ø3	
G2	mm inch	440.0 [217.32]	1000.0 [39.37]	963.0 [37.91]	913.6 [35.97]	13.0 [0.51]	26.5 [1.04]	27.0 [1.06]	22.0 [0.87]	34.0 [1.34]	117.5 [4.63]

# Dimensions

## ■ Frame H1

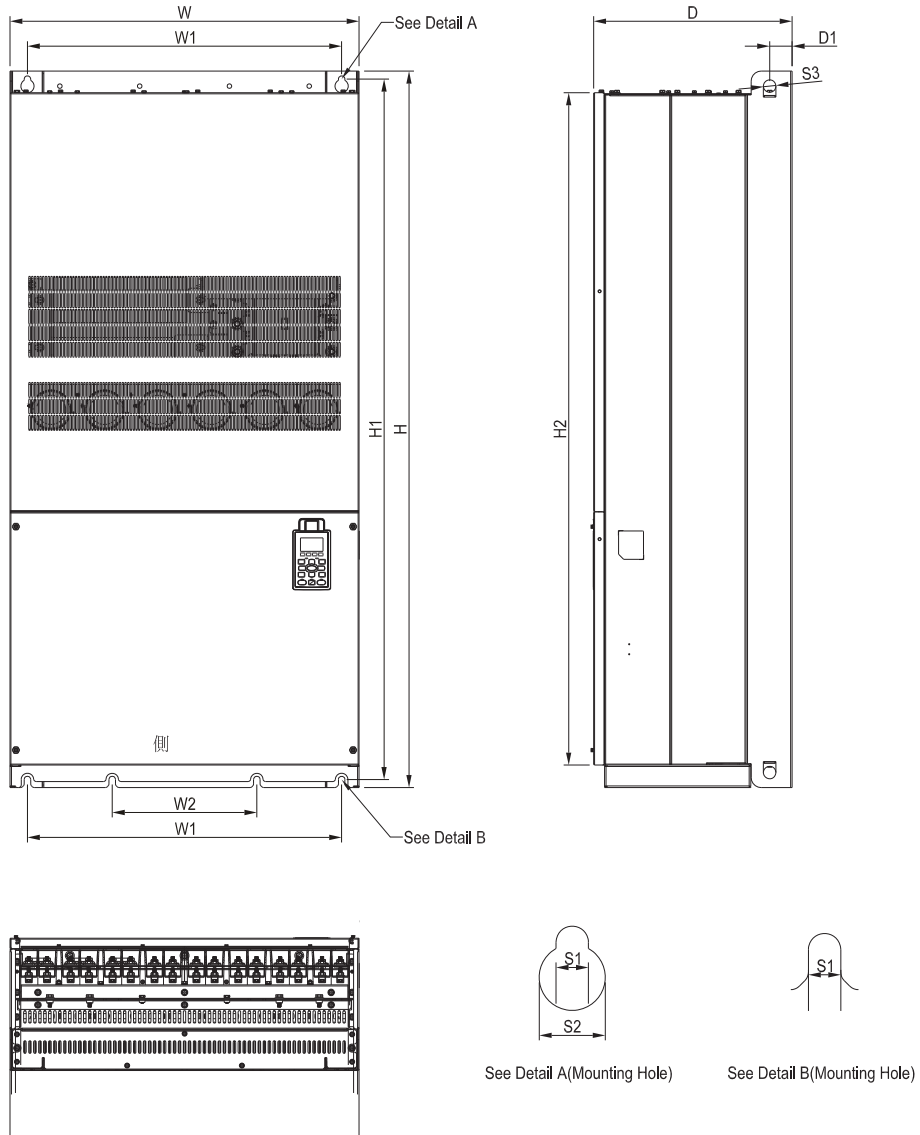

## MODEL

VFD2800CH43A-00

Unit : mm[inch]

Frame	W	H	D	W1	W2	W3	W4	W5	W6	H1	H2	H3	H4	
H1	mm inch	700.0 [27.56]	1435.0 [56.5]	398.0 [15.67]	630.0 [24.8]	290.0 [11.42]	-	-	-	-	1403.0 [55.24]	1346.0 [53.02]	-	-

Frame	H5	D1	D2	D3	D4	D5	D6	S1	S2	S3	Ø1	Ø2	Ø3
H1	mm inch	45.0 [1.77]	-	-	-	-	-	13.0 [0.51]	26.5 [1.04]	25.0 [0.98]	-	-	-

■ Frame H2

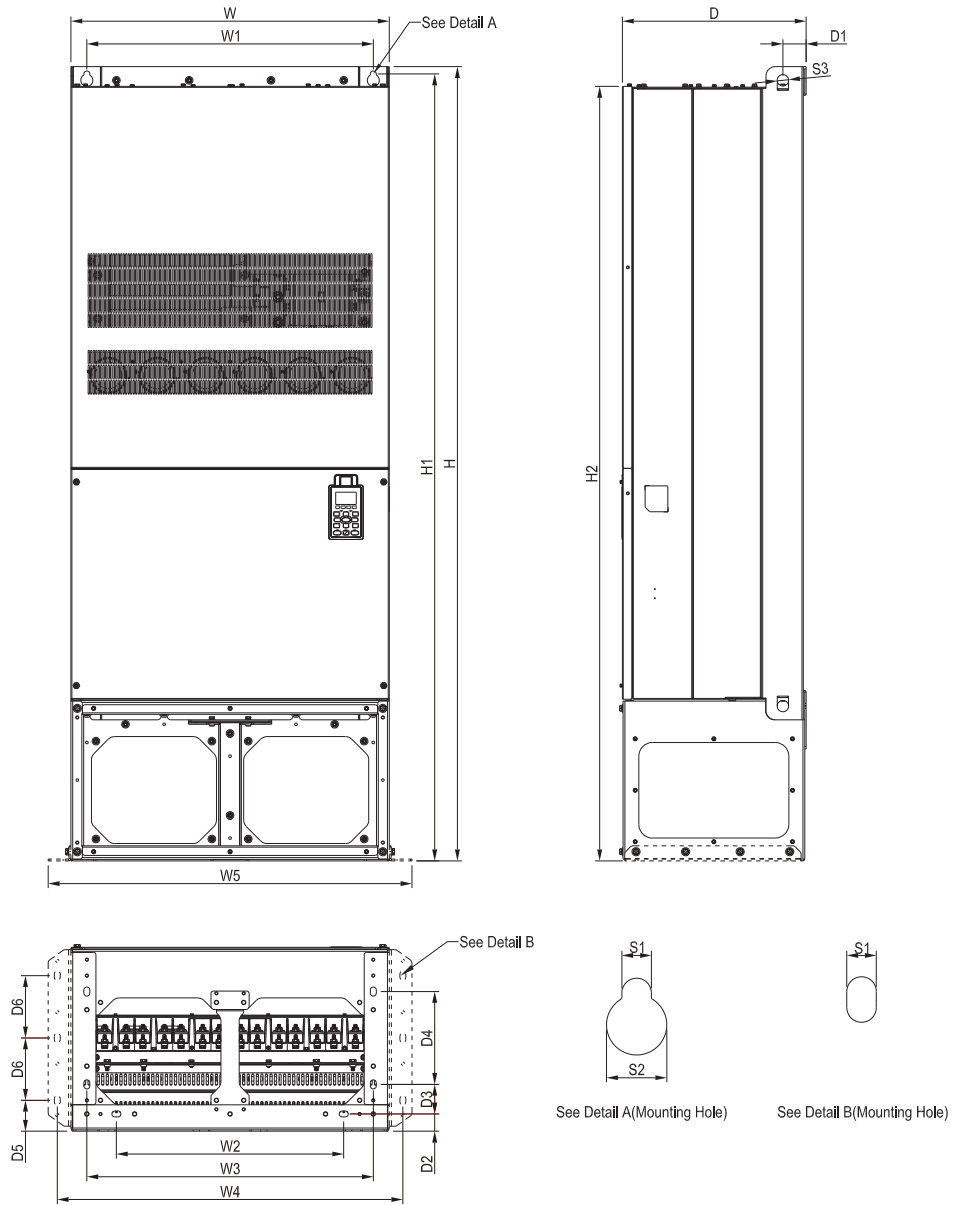

**MODEL**

VFD2800CH43C-00

Unit : mm[inch]

Frame	W	H	D	W1	W2	W3	W4	W5	W6	H1	H2	H3	H4	
H2	mm inch	700.0 [27.56]	1745.0 [68.70]	404.0 [15.91]	630.0 [24.8]	500.0 [19.69]	630.0 [24.80]	760.0 [29.92]	800.0 [31.5]	-	1729.0 [68.07]	1701.6 [66.99]	-	-
Frame	H5	D1	D2	D3	D4	D5	D6	S1	S2	S3	Ø 1	Ø 2	Ø 3	
H2	mm inch	51.0 [2.01]	38.0 [1.50]	65.0 [2.56]	204.0 [8.03]	68.0 [2.68]	137.0 [5.39]	13.0 [0.51]	26.5 [1.04]	25.0 [0.98]	-	-	-	



# Dimensions

## ■ Frame H3

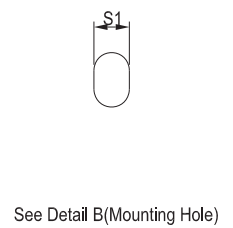
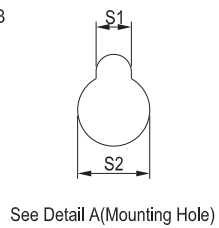
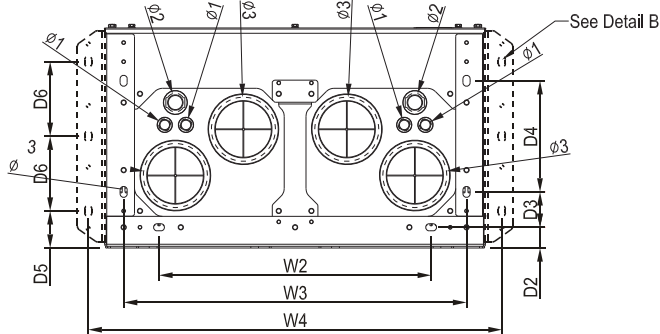
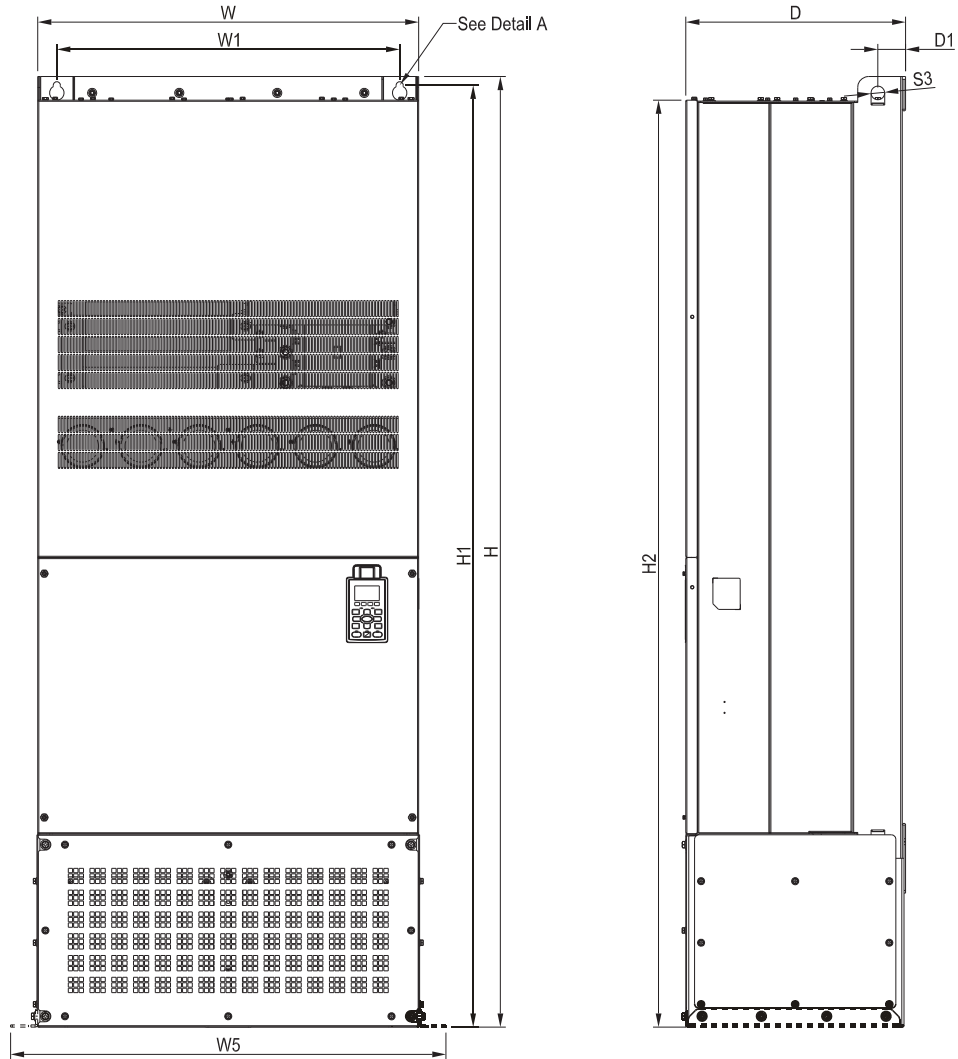

## MODEL

VFD2800CH43C-21

Unit : mm[inch]

Frame	W	H	D	W1	W2	W3	W4	W5	W6	H1	H2	H3	H4	
H3	mm inch	700.0 [27.56]	1435.0 [56.5]	404.0 [15.91]	630.0 [24.80]	500.0 [19.69]	630.0 [24.80]	760.0 [29.92]	800.0 [31.5]	-	1729.0 [68.07]	1701.6 [66.99]	-	-

Frame	H5	D1	D2	D3	D4	D5	D6	S1	S2	S3	Ø 1	Ø 2	Ø 3
H3	mm inch	51.0 [2.01]	38.0 [1.50]	65.0 [2.56]	204.0 [8.03]	68.0 [2.68]	137.0 [5.39]	13.0 [0.51]	26.5 [1.04]	25.0 [0.98]	22.0 [0.87]	34.0 [1.34]	117.5 [4.63]

# Option Cards

## EMC-PG01L

		Terminals	Descriptions
 <p>Set by Pr.10-00~10-02</p>	PG1	VP	Output voltage for power: +5V/+12V±5% (use FSW3 to switch +5V/+12V) Max. output current: 200mA
		DCM	Common for power and signal
		A1, /A1, B1, /B1, Z1, /Z1	Encoder input signal (Line Driver) 1-phase or 2-phase input; Max. Input frequency: 300kP/sec
	PG2	A2, /A2, B2, /B2	Pulse input signal (Line Driver or Open Collector) Open collector input: +5V/+12V (Note1) 1-phase or 2-phase input; Max. Input frequency: 300kP/sec.
	PG OUT	AO, /AO, BO, /BO, ZO, /ZO, SG	PG card output signals. Division frequency function: 1~255 times Max. output voltage for Line driver: 5Vdc Max. output current: 50mA; Max. output frequency: 300kP/sec SG: The GND of PG card is the same as the host controller or PLC, so a common output signal is attained.

## EMC-PG010

		Terminals	Descriptions
 <p>Set by Pr.10-00~10-02</p>	PG1	VP	Output voltage for power: +5V/+12V±5% (use FSW3 to switch +5V/+12V) Max. output current: 200mA
		DCM	Common for power and signal
		A1, /A1, B1, /B1, Z1, /Z1	Encoder input signal (Line Driver or Open Collector) Open collector input: +5V/+12V (Note1) 1-phase or 2-phase input; Max. Input frequency: 300kP/sec
	PG2	A2, /A2, B2, /B2	Pulse input signal (Line Driver or Open Collector) Open collector input: +5V/+12V (Note1) 1-phase or 2-phase input; Max. Input frequency: 300kP/sec
	PG OUT	V+, /V+	Needs external power source for PG OUT circuit Input voltage of power: +12V ~ +24V
V-		Negative power supply input	
A/O, B/O, Z/O		PG card output signals. Division frequency function: 1~255 times Add a pull-up resistor to the open collector output signals to avoid signal interferences. [Three pull-up resistors are included in the package (1.8kΩ/1W)] Max. Output current: 20mA; Max output frequency: 300KP/Sec	

## EMC-PG01R

		Terminals	Descriptions
 <p>Set by Pr.10-00~10-02</p>	PG1	R1- R2	Resolver output power 7Vrms, 10kHz
		S1, S2, S3, S4,	Resolver input signal 3.5±0.175Vrms, 10kHz
	PG2	A2, /A2 B2, /B2	Pulse input signal (line driver or open collector) Open collector input: +5V/+12V (Note1) 1-phase or 2-phase input; Max. output frequency: 300kP/sec.
	PG OUT	AO, /AO, BO, /BO, ZO, /ZO, SG	PG card output signals. Division frequency function: 1~255 times Max. output voltage for Line driver: 5Vdc Max. output current: 50mA Max. Input frequency: 300kP/sec SG: The GND of PG card is the same as the host controller or PLC, so a common output signal is attained.

# Option Cards

## EMC-PG01U

■ FSW1  : Standard UVW Output Encoder;  : Delta Encoder

		Terminals	Descriptions
 Set by Pr.10-00~10-02	PG1	VP	Output voltage for power: +5V/+12V5% (use FSW3 to switch +5V/+12V) Max. output current: 200mA
		DCM	Common for power and signal
		A1, /A1, B1, /B1, Z1, /Z1	Encoder input signal (Line Driver) 1-phase or 2-phase input Max. Input frequency: 300kP/sec
		U1, /U1, V1, /V1, W1, /W1	Encoder input signal
	PG2	A2, /A2 B2, /B2	Pulse Input signal Open collector input: +5V/+12V (Note1) 1-phase or 2-phase input; Max. Input frequency: 300kP/sec
	PG OUT	AO, /AO, BO, /BO, ZO, /ZO, SG	PG card output signals. Division frequency function: 1~255 times Max. output voltage for Line driver: 5Vdc Max. output current: 50mA Max. output frequency: 300kP/sec SG: The GND of PG card is the same as the host controller or PLC, so a common output signal is attained.

Note 1: For the Open Collector, set input voltage to 5~15mA and install a pull-up resistor

**[5V]** Recommended pull-up resistor: 100~220Ω · 1/2W and above

**[12V]** Recommended pull-up resistor: 510~1.35kΩ · 1/2W and above

**[24V]** Recommended pull-up resistor: 1.8k~3.3kΩ · 1/2W and above

# Screw Specifications for Option Card Terminals

EMC-D42A / EMC-D611A EMC-BPS01	Wire gauge	24~12AWG ( 0.205~3.31mm <sup>2</sup> )
	Torque	4Kg-cm [3.47lb-in]
EMC-R6AA	Wire gauge	24~16AWG ( 0.205~1.31mm <sup>2</sup> )
	Torque	6Kg-cm [5.21lb-in]
EMC-PG01L / EMC-PG01O EMC-PG01R / EMC-PG01U	Wire gauge	30~16AWG ( 0.0509~1.31mm <sup>2</sup> )
	Torque	2Kg-cm [1.74lb-in]



## EMC-D42A

	Terminals	Descriptions
	COM	Common for multi-function input terminals Select SINK (NPN) /SOURCE (PNP) in J1 jumper / external power supply
	MI10~ MI13	Refer to parameters 02-26~02-29 to program the multi-function inputs MI10~MI13. Internal power is applied from terminal E24: +24Vdc±5% 200mA, 5W External power +24Vdc: max. voltage 30Vdc, min. voltage 19Vdc, 30W ON: the activation current is 6.5mA; OFF: leakage current tolerance is 10iA
	MO10~MO11	Multi-function output terminals (photocoupler) Duty-cycle: 50%; Max. output frequency: 100Hz Max. current: 50mA; Max. voltage: 48Vdc
	MXM	Common for multi-function output terminals MO10, MO11(photocoupler) Max 48Vdc 50mA

## EMC-D611A

	Terminals	Descriptions
	AC	AC power common for multi-function input terminal (Neutral)
	MI10~ MI15	Refer to Pr. 02.26~ Pr. 02.31 for multi-function input selection Input voltage: 100~130VAC; Input frequency: 57~63Hz Input impedance: 27Kohm Terminal response time: ON: 10ms; OFF: 20ms

## EMC-R6AA

 <p>Relay Extension Card</p>	Terminals	Descriptions
	RA10~RA15 RC10~RC15	Refer to Pr. 02.36~ Pr. 02.41 for multi-function input selection Resistive load: 3A(N.O.)/250VAC 5A(N.O.)/30Vdc Inductive load (COSPHI 0.4) 2.0A(N.O.)/250VAC 2.0A(N.O.)/30Vdc It is used to output each monitor signal, such as for drive in operation, frequency attained or overload indication.

## EMC-BPS01

 <p>External Power Supply Card</p>	Terminals	Descriptions
	24V GND	Input power: 24V±5% Maximum input current:0.5A Note: (1) Do not connect the control terminal +24V (Digital control signal common: SOURCE) directly to the EMC-BPS01 input terminal 24V. (2) Do not connect control terminal GND directly to the EMC-BPS01 input terminal GND.

## CMC-MOD01



### Features

- RJ-45 with Auto MDI/MDIX
- 10/100Mbps Auto-Detect
- 1 Port
- IEEE 802.3, IEEE 802.3u
- SFP
- Category 5e shielding 100M

### Network Interface

Interface	RJ-45 with Auto MDI/MDIX	Transmission speed	10/100 Mbps Auto-Detect
Number of ports	1 Port	Network protocol	ICMP, IP, TCP, UDP, DHCP, SMTP, MODBUS OVER TCP/IP, Delta Configuration
Transmission method	IEEE 802.3, IEEE 802.3u		
Transmission cable	Category 5e shielding 100M		



# Option Cards

## CMC-EIP01



### Features

- MDI/MDI-X auto-detect
- Supports MODBUS TCP and Ethernet/IP protocol
- Baud rate: 10/100Mbps auto-detect
- AC motor drive keypad/Ethernet configuration
- Virtual serial port

### Network Interface

Interface	RJ-45 with Auto MDI/MDIX
Number of ports	1 Port
Transmission method	IEEE 802.3, IEEE 802.3u
Transmission cable	Category 5e shielding 100M

Transmission speed	10/100 Mbps Auto-Detect
Network protocol	ICMP, IP, TCP, UDP, DHCP, SMTP, MODBUS OVER TCP/IP, Delta Configuration

## CMC-PD01



### Features

- Supports PZD control data exchange
- Supports PKW polling AC motor drive parameters
- Supports user diagnosis function
- Auto-detects baud rates; supports Max. 12Mbps

### PROFIBUS DP Connector

Interface	DB9 connector (180° connector)
Transmission method	High-speed RS-485
Transmission cable	Shielded twisted pair cable
Electrical isolation	500VDC

### Communication

Message type	Cyclic data exchange
Module name	CMC-PD01
GSD document	DELA08DB.GSD
Company ID	08DB (HEX)
Serial transmission speed supported (auto-detection)	9.6kbps; 19.2kbps; 93.75kbps; 187.5kbps; 125kbps; 250kbps; 500kbps; 1.5Mbps; 3Mbps; 6Mbps; 12Mbps (bits per second)

## CMC-DN01



### Features

- Based on the high-speed communication interface of Delta HSSP protocol, able to conduct immediate control of AC motor drive
- Supports Group 2 only connection and polling I/O data exchange
- For I/O mapping, supports Max. 32 words of input and 32 words of output
- Supports EDS file configuration in DeviceNet configuration software
- Supports all baud rates on DeviceNet bus: 125kbps, 250kbps, 500kbps and extendable serial transmission speed mode
- Node address and serial transmission speed can be set up on AC motor drive
- Power supplied from AC motor drive

### DeviceNet Connector

Interface	5-PIN open removable connector. Of 5.08mm PIN interval
Transmission method	CAN
Transmission cable	Shielded twisted pair cable (with 2 power cables)
Transmission speed	125kbps, 250kbps, 500kbps and extendable serial transmission speed mode
Network protocol	DeviceNet protocol

### AC Motor Drive Connection Port

Interface	50 PIN communication terminal
Transmission method	SPI communication
Terminal function	1. Communicating with AC motor drive 2. Transmitting power supply from AC motor drive
Communication protocol	Delta HSSP protocol

## EMC-COP01



### RJ-45 Pin definition

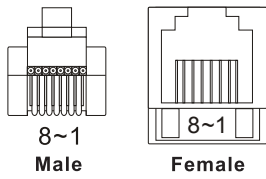

Pin	Pin name	Definition
1	CAN_H	CAN_H bus line (dominant high)
2	CAN_L	CAN_L bus line (dominant low)
3	CAN_GND	Ground/0V/V-
6	CAN_GND	Ground/0V/V-

### Specification

Interface	RJ-45
Number of ports	1 Port
Transmission method	CAN
Transmission cable	CAN standard cable
Transmission speed	1M 500k 250k 125k 100k 50k
Communication protocol	CANopen

## CANopen Communication Cable

Model: TAP-CB05, TAP-CB10

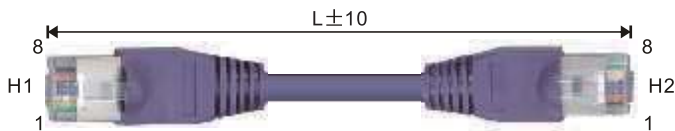

Port	Port	Length	
		mm	inch
1	TAP-CB05	500±10	19±0.4
2	TAP-CB10	1000±10	39±0.4

## Digital Keypad Accessories: RJ45 Extension Leads and CMC-EIP01 Cables



Applicable Models : CBC-K3FT ; CBC-K5FT ; CBC-K7FT ; CBC-K10F ; CBC-K16FT

Title	Part No.	Explanation
1	CBC-K3FT	RJ45 extension lead, 3 feet (approximately 0.9m)
2	CBC-K5FT	RJ45 extension lead, 5 feet (approximately 1.5m)
3	CBC-K7FT	RJ45 extension lead, 7 feet (approximately 2.1m)
4	CBC-K10FT	RJ45 extension lead, 10 feet (approximately 3m)
5	CBC-K16FT	RJ45 extension lead, 16 feet (approximately 4.9m)



# Ordering Information

<p><b>Frame A</b></p> 	<p><b>230V:</b> 0.75kW~3.7kW</p> <p><b>460V:</b> 0.75kW~5.5kW</p>	<p>VFD007CH23A-21 VFD015CH23A-21 VFD022CH23A-21 VFD037CH23A-21</p>	<p>VFD007CH43A-21 VFD015CH43A-21 VFD022CH43A-21 VFD037CH43A-21 VFD055CH43A-21</p>	<p>VFD007CH4EA-21 VFD015CH4EA-21 VFD022CH4EA-21 VFD037CH4EA-21 VFD055CH4EA-21</p>
<p><b>Frame B</b></p> 	<p><b>230V:</b> 5.5kW~11kW</p> <p><b>460V:</b> 7.5kW~15kW</p>	<p>VFD055CH23A-21 VFD075CH23A-21 VFD110CH23A-21</p>	<p>VFD075CH43A-21 VFD110CH43A-21 VFD150CH43A-21</p>	<p>VFD075CH4EA-21 VFD110CH4EA-21 VFD150CH4EA-21</p>
<p><b>Frame C</b></p> 	<p><b>230V:</b> 15kW~18.5kW</p> <p><b>460V:</b> 18.5kW~30kW</p>	<p>VFD150CH23A-21 VFD185CH23A-21</p>	<p>VFD185CH43A-21 VFD220CH43A-21 VFD300CH43A-21</p>	<p>VFD185CH4EA-21 VFD220CH4EA-21 VFD300CH4EA-21</p>
<p><b>Frame D</b></p> 	<p><b>230V:</b> 22kW~37kW</p> <p><b>460V:</b> 37kW~75kW</p>	<p><b>Frame D1:</b> VFD220CH23A-00 VFD300CH23A-00 VFD370CH23A-00 VFD450CH43A-00 VFD550CH43A-00 VFD750CH43A-00</p>	<p><b>Frame D2:</b> VFD220CH23A-21 VFD300CH23A-21 VFD370CH23A-21 VFD450CH43A-21 VFD550CH43A-21 VFD750CH43A-21</p>	<p><b>Frame D0-2:</b> VFD370CH43S-21</p>
<p><b>Frame E</b></p> 	<p><b>230V:</b> 45kW~55kW</p> <p><b>460V:</b> 90kW~110kW</p>	<p><b>Frame E1:</b> VFD450CH23A-00 VFD550CH23A-00 VFD900CH43A-00 VFD1100CH43A-00</p>	<p><b>Frame E2:</b> VFD450CH23A-21 VFD550CH23A-21 VFD900CH43A-21 VFD1100CH43A-21</p>	
<p><b>Frame F</b></p> 	<p><b>230V:</b> 75kW</p> <p><b>400V:</b> 132kW</p>	<p><b>Frame F1:</b> VFD750CH23A-00 VFD1320CH43A00</p>	<p><b>Frame F2:</b> VFD750CH23A-21 VFD1320CH43A-21</p>	

<p><b>Frame G</b></p> 	<p><b>460V:</b> 160kW~220kW</p>	<p><b>Frame G1:</b> VFD1600CH43A-00 VFD1850CH43A-00 VFD2200CH43A-00</p> <p><b>Frame G2:</b> VFD1600CH43A-21 VFD1850CH43A-21 VFD2200CH43A-21</p>
<p><b>Frame H</b></p> 	<p><b>460V:</b> 280kW</p>	<p><b>Frame H1:</b> VFD2800CH43A-00</p> <p><b>Frame H2:</b> VFD2800CH43C-00</p> <p><b>Frame H3:</b> VFD2800CH43C-21</p>

## Model Name

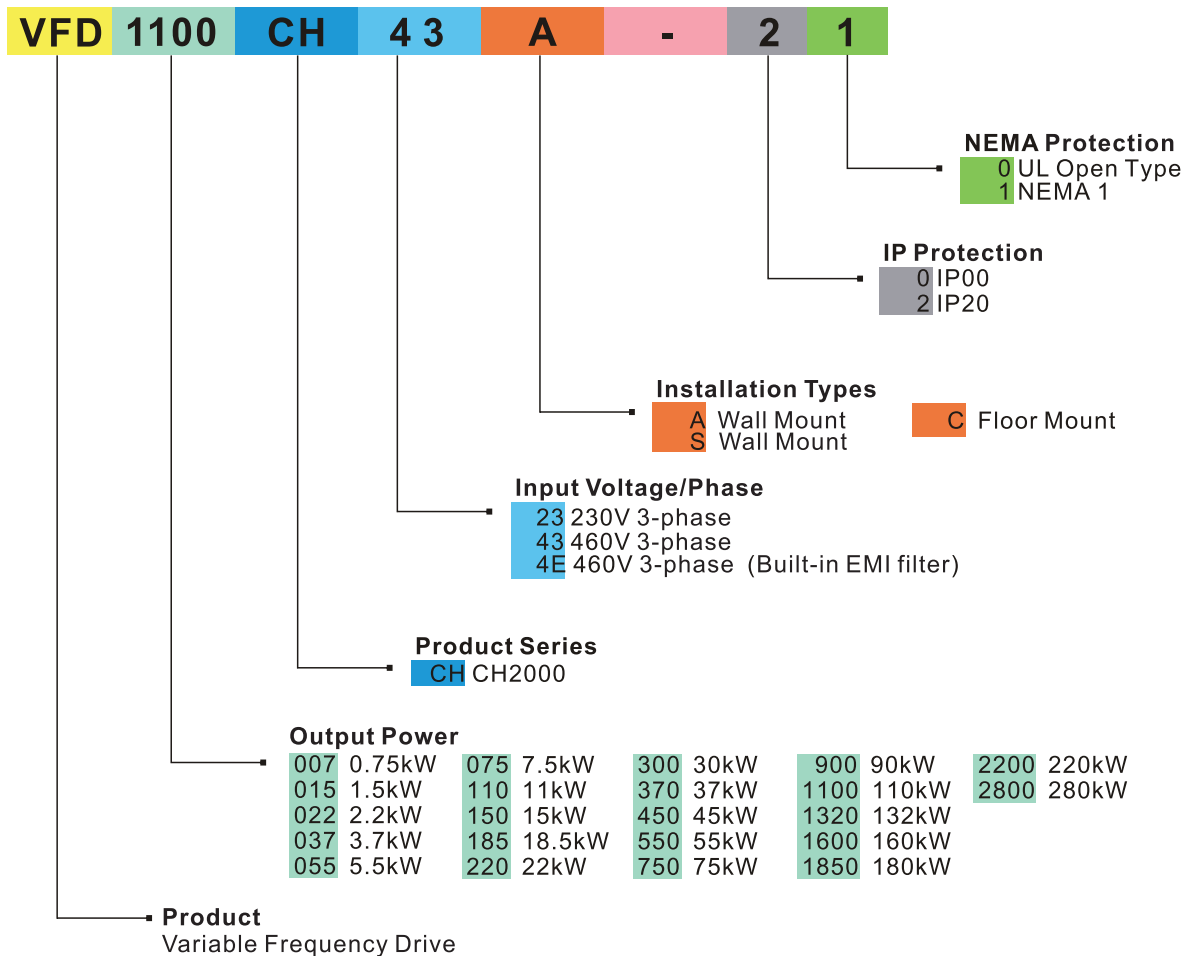

## Asia



Taoyuan Technology Center



Taoyuan Plant 1



Taiwan's First Green Factory



Wujiang Plant 3



China Delta Greentech

## Global Operations

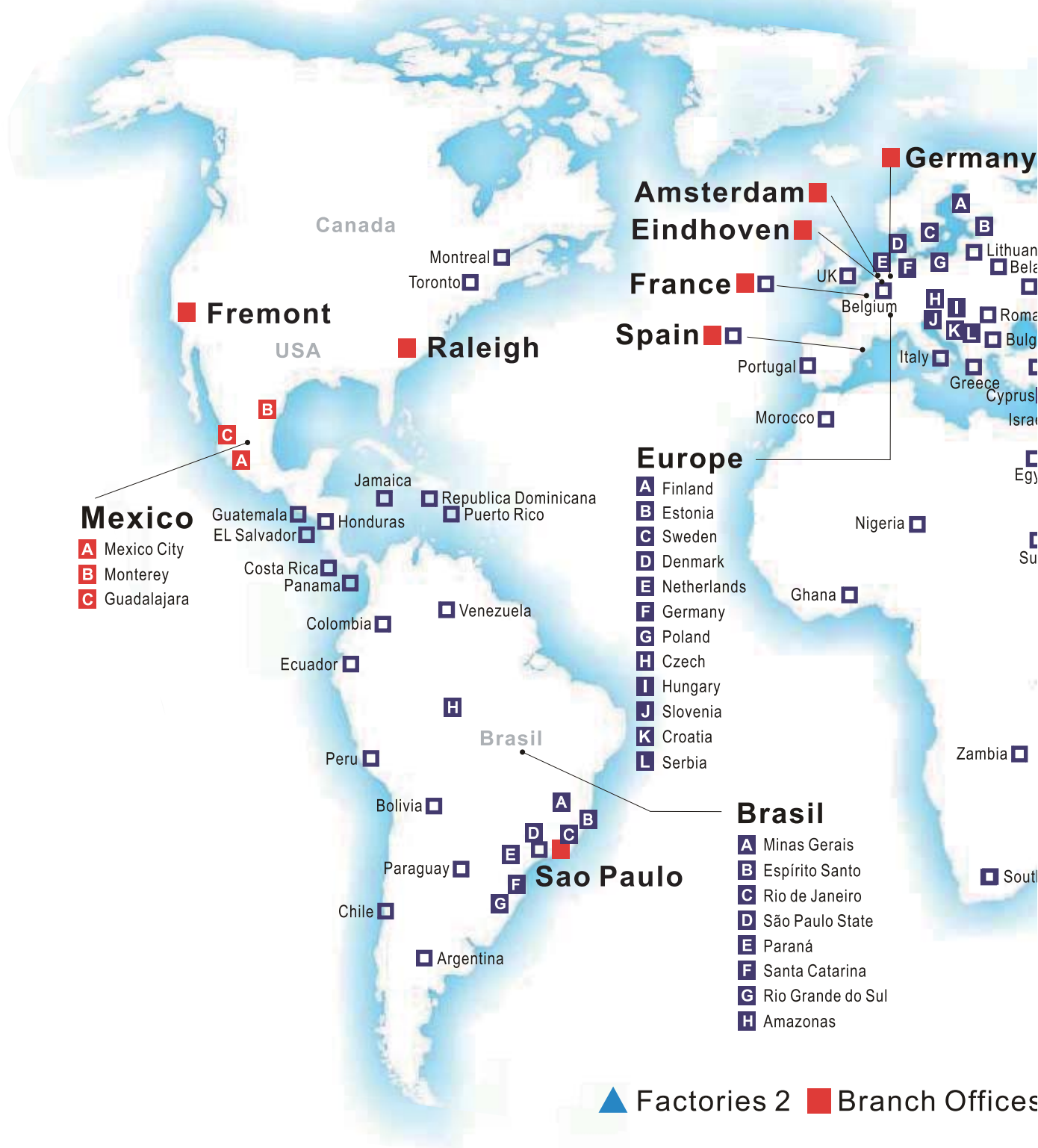





Tokyo Office



India Office



Eindhoven Office



Raleigh Office

### Europe

### America

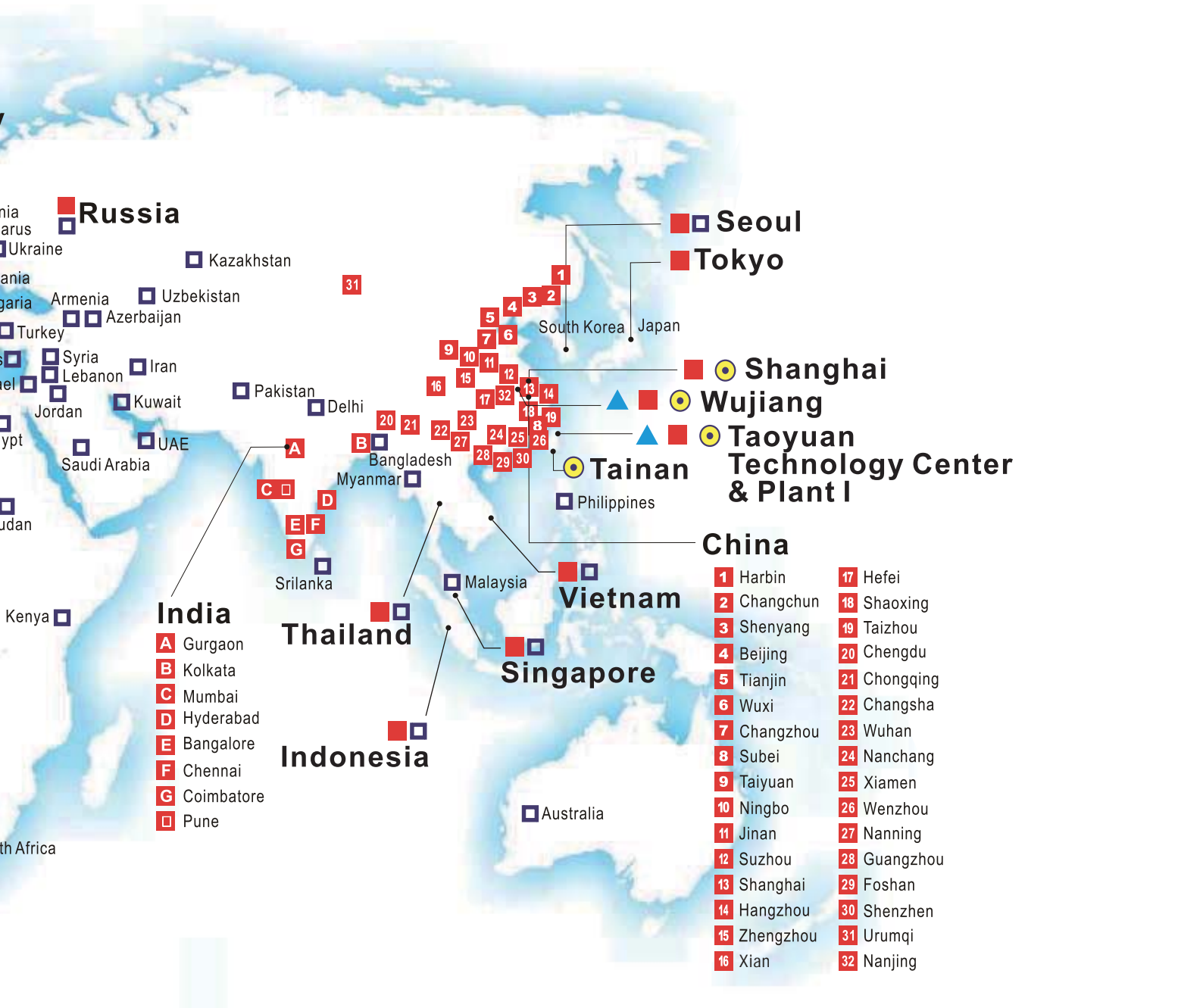

s 64 R&D Centers 4 Distributors 584



Smarter. Greener. Together.

## Industrial Automation Headquarters

### Delta Electronics, Inc.

Taoyuan Technology Center  
No.18, Xinglong Rd., Taoyuan City,  
Taoyuan County 33068, Taiwan  
TEL: 886-3-362-6301 / FAX: 886-3-371-6301

## Asia

### Delta Electronics (Jiangsu) Ltd.

Wujiang Plant 3  
1688 Jiangxing East Road,  
Wujiang Economic Development Zone  
Wujiang City, Jiang Su Province, P.R.C. 215200  
TEL: 86-512-6340-3008 / FAX: 86-769-6340-7290

### Delta Greentech (China) Co., Ltd.

238 Min-Xia Road, Pudong District,  
ShangHai, P.R.C. 201209  
TEL: 86-21-58635678 / FAX: 86-21-58630003

### Delta Electronics (Japan), Inc.

Tokyo Office  
2-1-14 Minato-ku Shibadaimon,  
Tokyo 105-0012, Japan  
TEL: 81-3-5733-1111 / FAX: 81-3-5733-1211

### Delta Electronics (Korea), Inc.

1511, Byucksan Digital Valley 6-cha, Gasan-dong,  
Geumcheon-gu, Seoul, Korea, 153-704  
TEL: 82-2-515-5303 / FAX: 82-2-515-5302

### Delta Electronics Int'l (S) Pte Ltd.

4 Kaki Bukit Ave 1, #05-05, Singapore 417939  
TEL: 65-6747-5155 / FAX: 65-6744-9228

### Delta Electronics (India) Pvt. Ltd.

Plot No 43 Sector 35, HSIIDC  
Gurgaon, PIN 122001, Haryana, India  
TEL : 91-124-4874900 / FAX : 91-124-4874945

## Americas

### Delta Products Corporation (USA)

Raleigh Office  
P.O. Box 12173, 5101 Davis Drive,  
Research Triangle Park, NC 27709, U.S.A.  
TEL: 1-919-767-3800 / FAX: 1-919-767-8080

### Delta Greentech (Brasil) S.A.

Sao Paulo Office  
Rua Itapeva, 26 - 3° andar Edificio Itapeva One-Bela Vista  
01332-000-São Paulo-SP-Brazil  
TEL: 55 11 3568-3855 / FAX: 55 11 3568-3865

## Europe

### Deltronics (The Netherlands) B.V.

Eindhoven Office  
De Witbogt 15, 5652 AG Eindhoven, The Netherlands  
TEL: 31-40-2592850 / FAX: 31-40-2592851

\*We reserve the right to change the information in this catalogue without prior notice.